

GEOMETRİK CİSİMLER

● Aşağıdaki geometrik cisimlerin isimlerini altlarına yazınız.

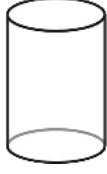

● Aşağıdaki nesnelerin hangi geometrik cisimlere benzediğini altlarına yazınız.

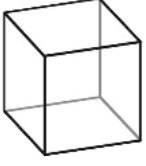
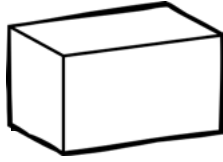
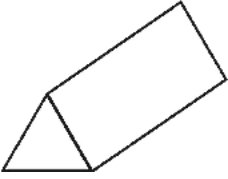
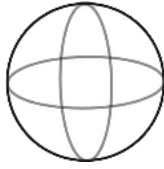
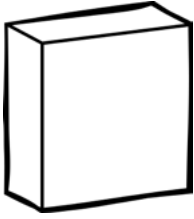

● Aşağıdaki geometrik cisimlerle isimlerini harfleri kullanarak eşleştiriniz.

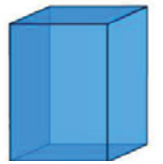
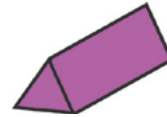
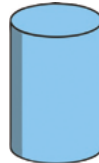
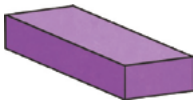

R

N

İ

F

A

E

Üçgen
Prizma

Silindir

Kare
Prizma

Küre

Küp

Dikdörtgen
Prizma

.....

.....

.....

.....

.....

.....

- Aşağıdaki nesnelere üçgen prizmaya benzeyenleri işaretleyiniz.











- Aşağıdaki nesnelere kare prizmaya benzeyenleri işaretleyiniz.









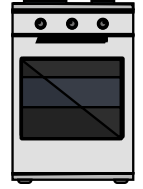

- Aşağıdaki nesnelere silindire benzeyenleri işaretleyiniz.











- Aşağıdaki nesnelere küpe benzeyenleri işaretleyiniz.











- Aşağıdaki nesnelere dikdörtgen prizmaya benzeyenleri işaretleyiniz.

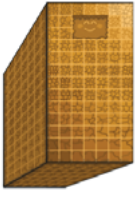

- Aşağıdaki nesnelere küreye benzeyenleri işaretleyiniz.



- Aşağıda verilen geometrik cisimleri yüzleriyle ve yüzün isimleriyle eşleştiriniz.



Üçgen

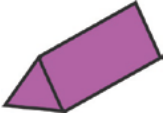

Çember

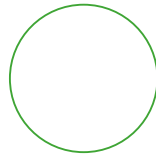
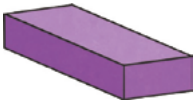

Dikdörtgen

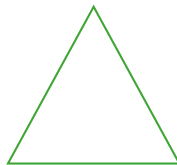
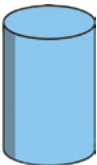

Kare

1. Aşağıdaki geometrik cisimleri boyayalım. İsimlerini boşluklara yazalım.

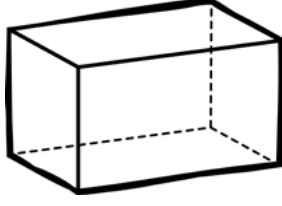
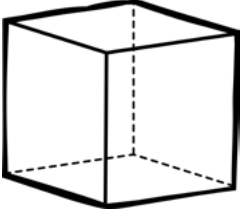

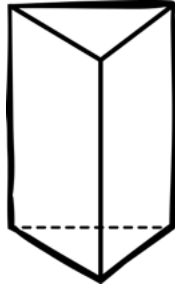
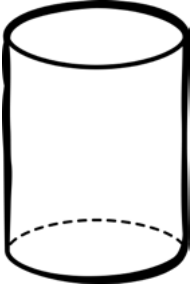

2. Aşağıdaki geometrik cisimlerin isimlerini yazalım.

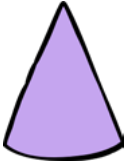

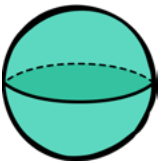

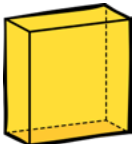

3. Aşağıdaki nesnelerin hangi geometrik cisimlere benzediğini uygun alanlara yazınız.

1 	2 	3 	4 
5 	6 	7 	8 
1	2	3	4
5	6	7	8

ilkokul1.com

4. Aşağıdaki geometrik cisimlere gerçek hayattan örnekler verelim.

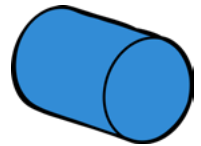

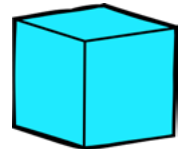

1. Aşağıdaki görseller, yanlarında verilen hangi geometrik cisme benziyor? İşaretleyelim.

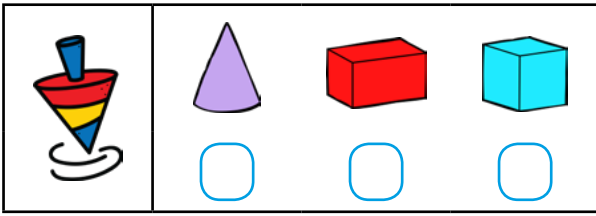
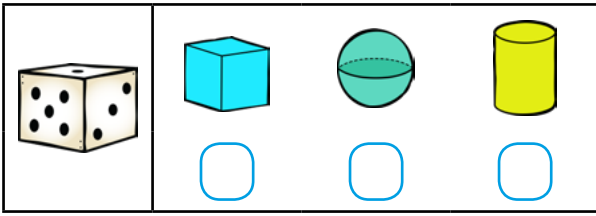
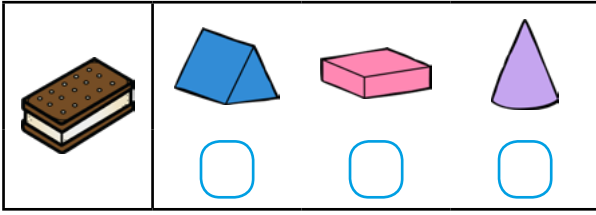
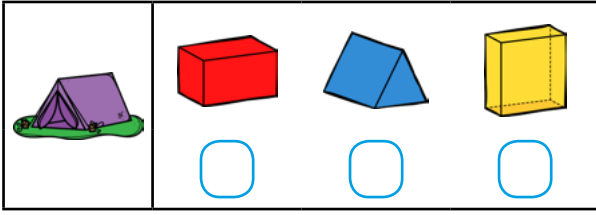
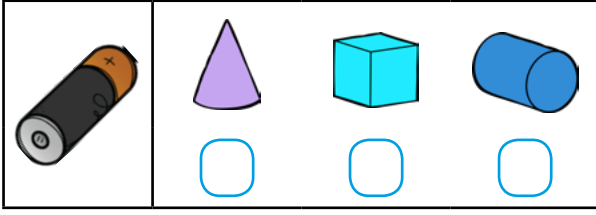
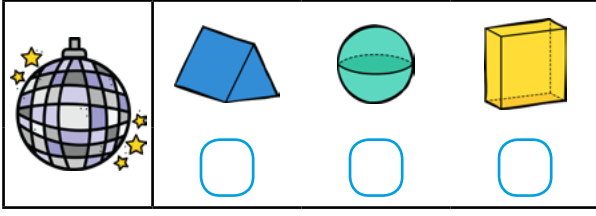

2. Aşağıdaki geometrik cisimleri yüzleriyle ve yüzün ismiyle örnekteki gibi aynı renge boyayarak eşleştirelim.

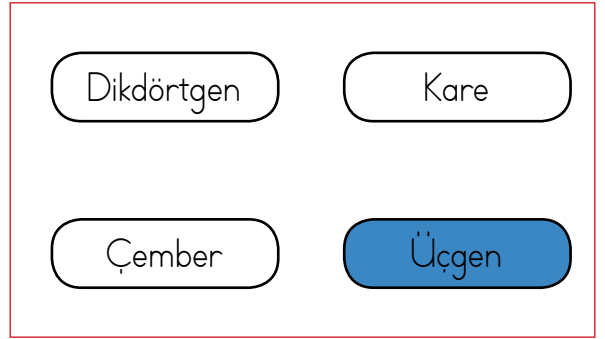
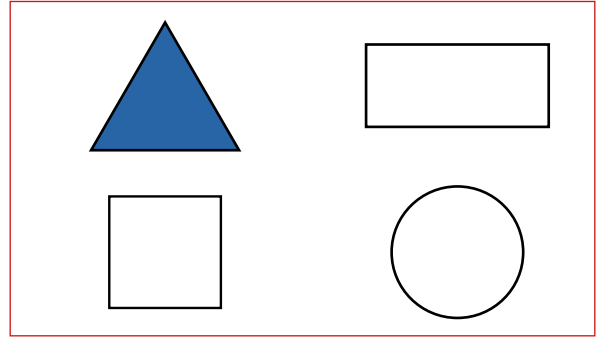
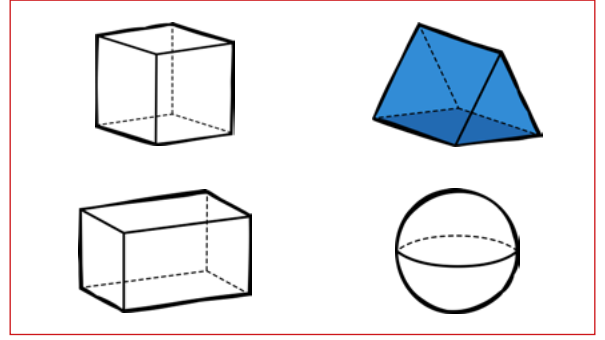

4. Aşağıdaki görsellerden özellikleri diğerlerinden farklı olanı boyayalım.

