

MATEMATİK 1

RAKAMLAR
ETKİNLİK KİTAPÇIĞI



ilkokul1.com

ELVAN PEKŞEN
EMRAH PEKŞEN

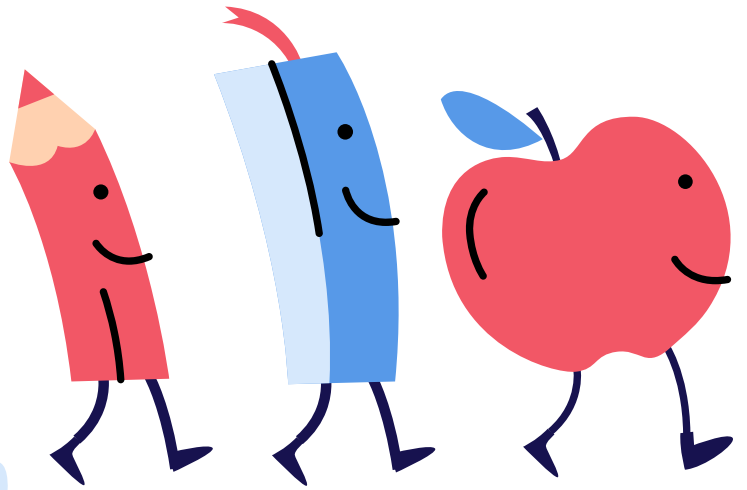

1 RAKAMI

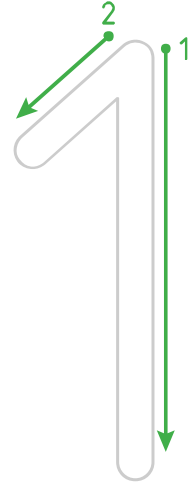
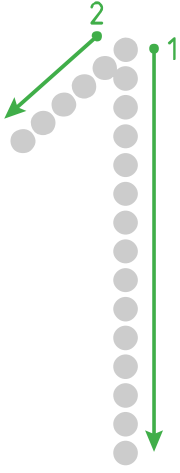

● 1 rakamını yazınız.

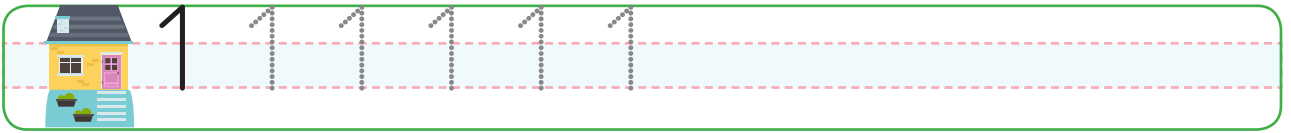
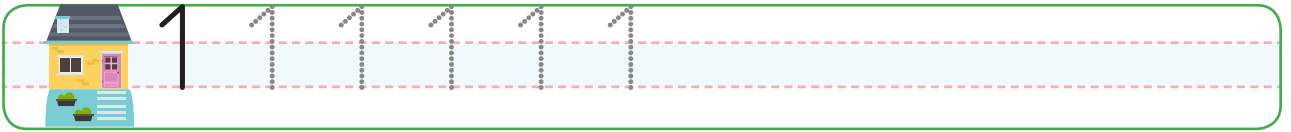
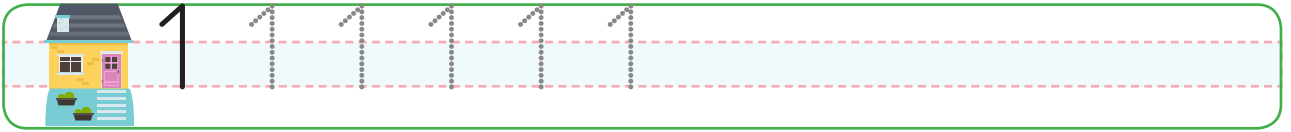
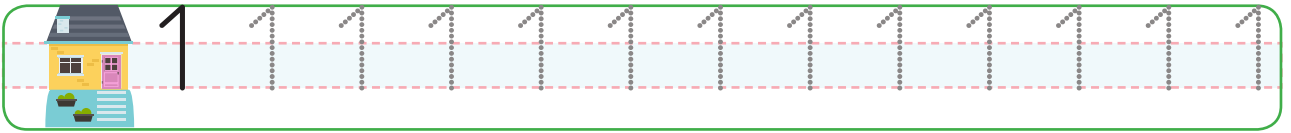

- 1 varlıktan oluşan kutuları işaretleyiniz.

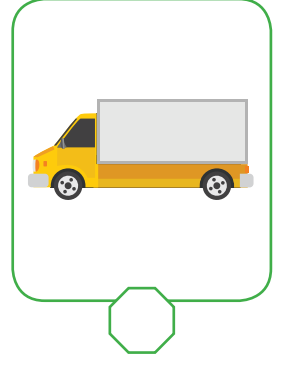
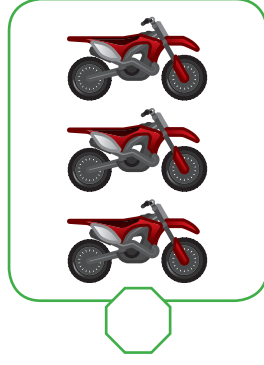
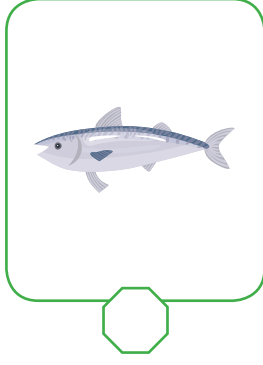
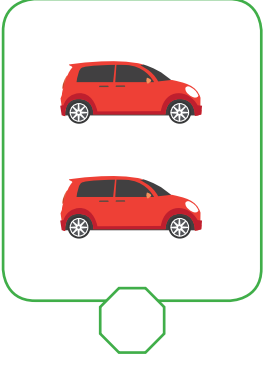

- İçinde 1 yazan elmaları kırmızıya boyayınız.

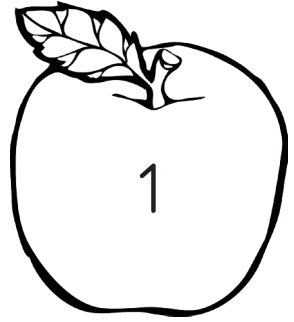
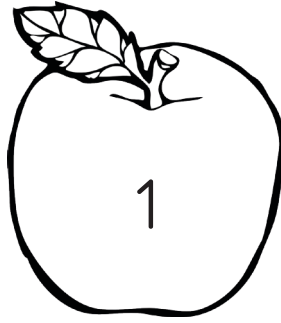
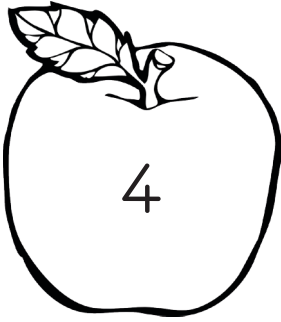
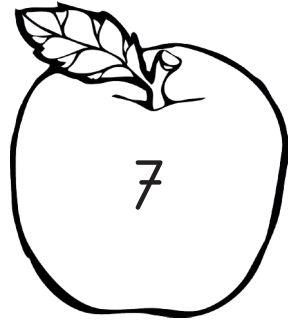
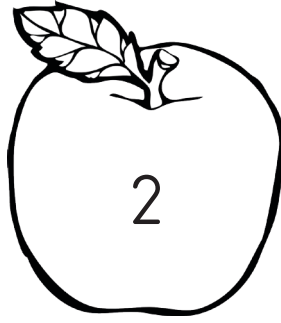
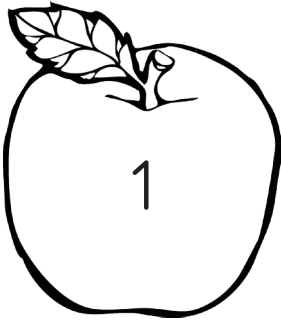

- 1 rakamını yazınız.

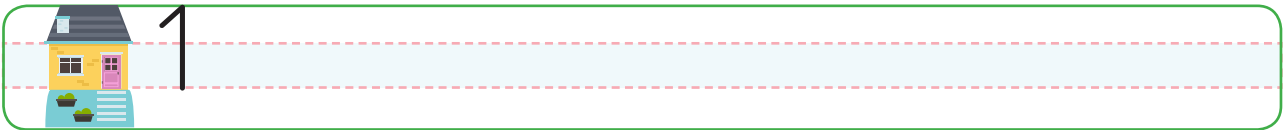

2 RAKAMI

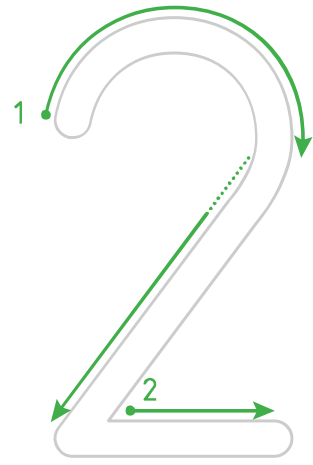
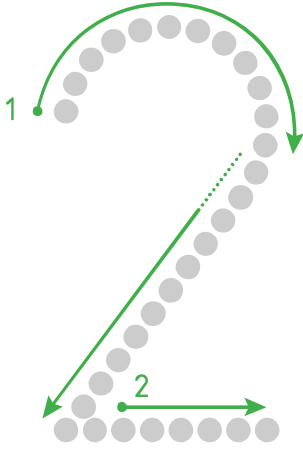

● 2 rakamını yazınız.

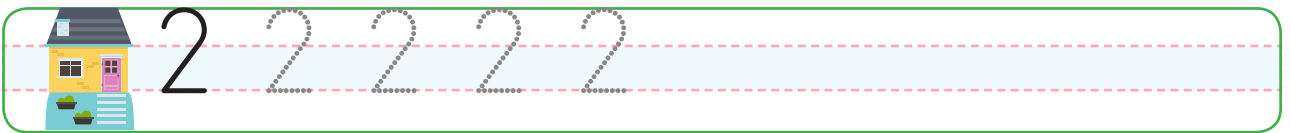
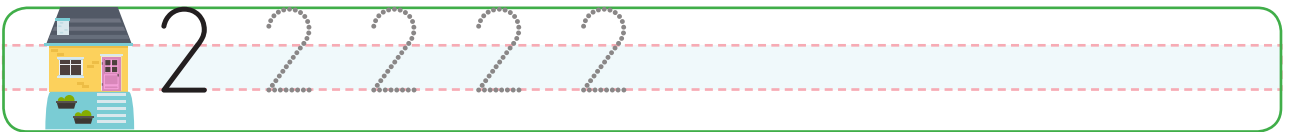
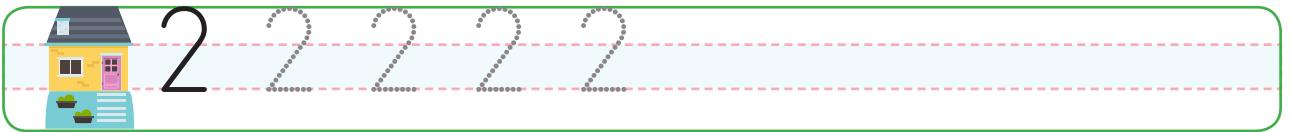
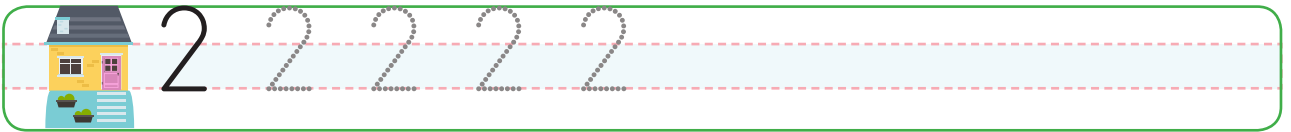
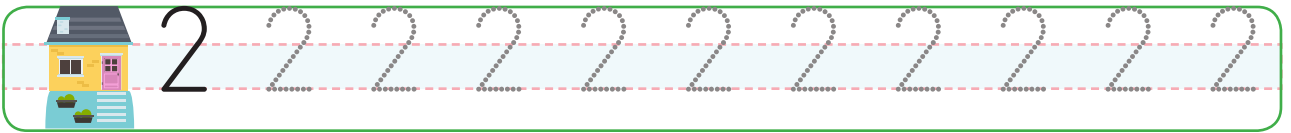
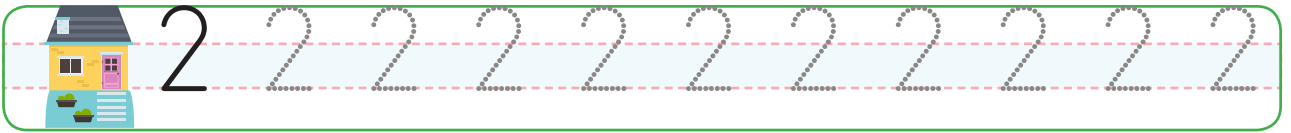
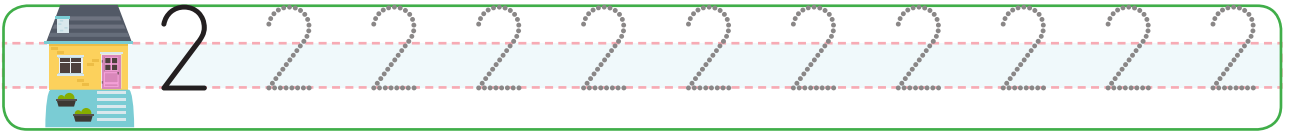
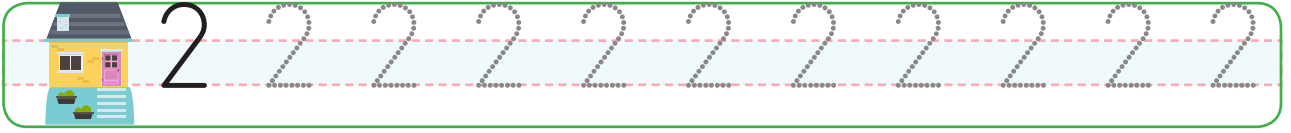

● 2 varlıktan oluşan kutuları işaretleyiniz.

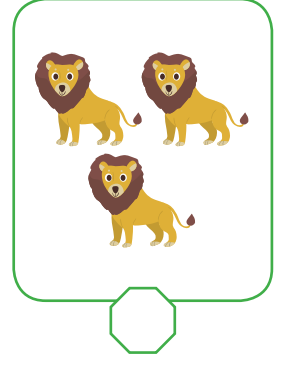
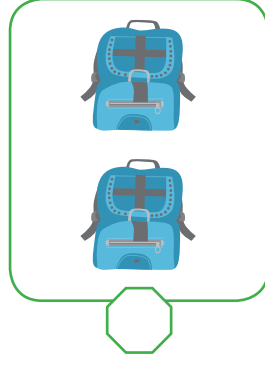
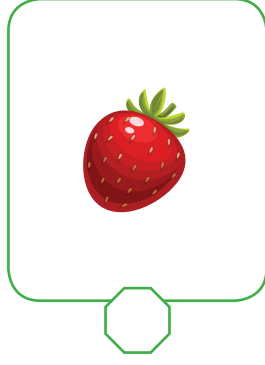
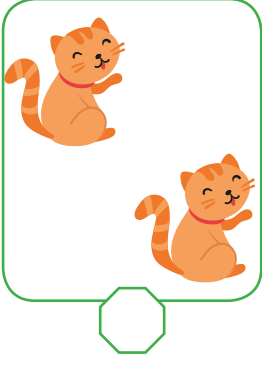

● İçinde 2 yazan tavşanları kahverengiye boyayınız.

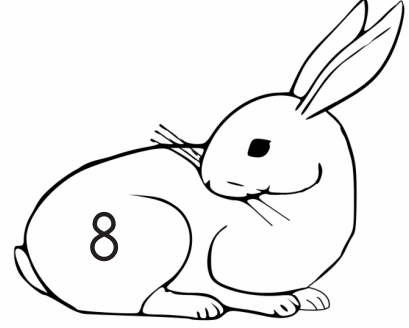
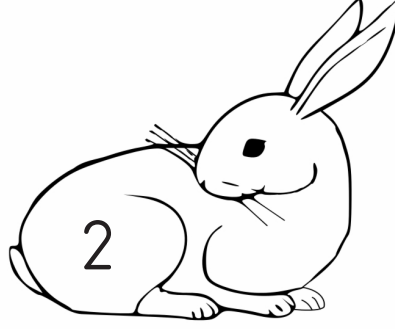
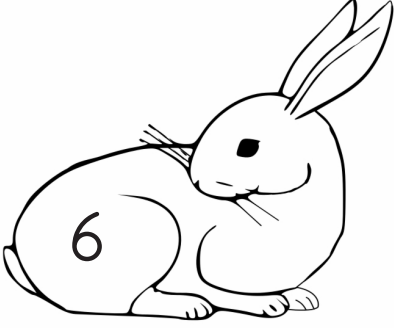
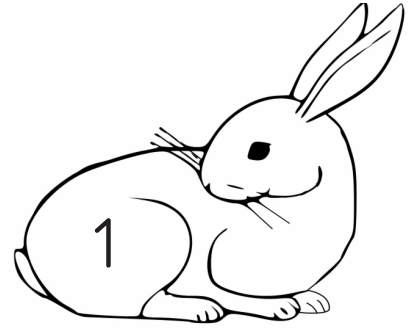
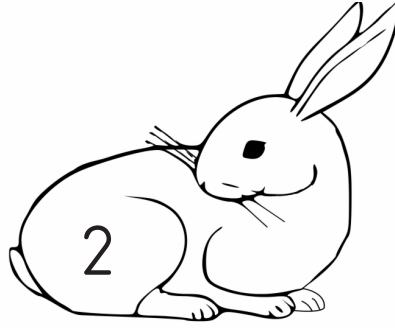
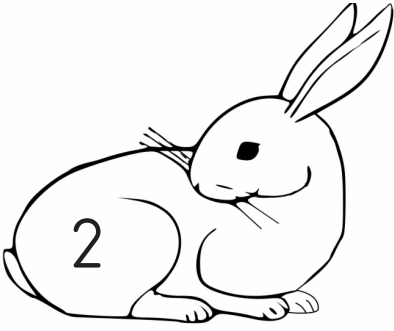

● 2 rakamını yazınız.



3 RAKAMI

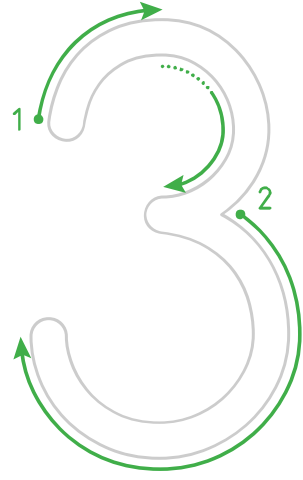
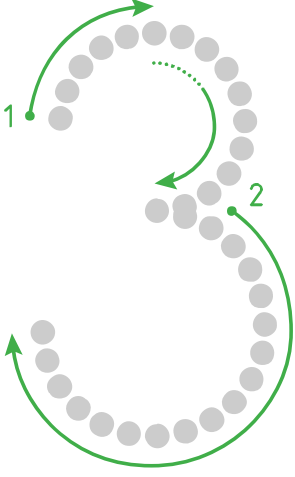

● 3 rakamını yazınız.

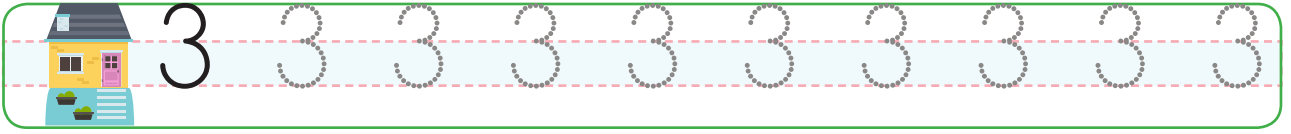
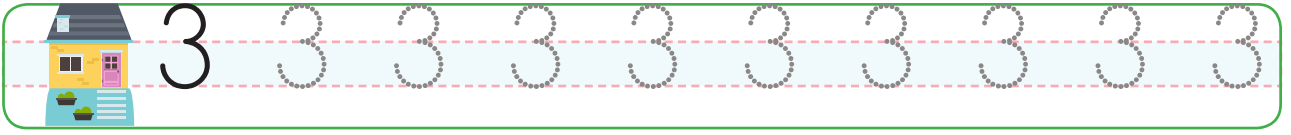
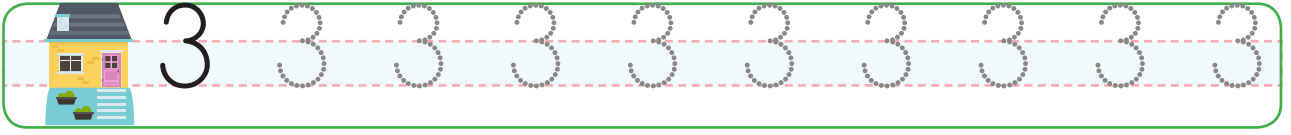
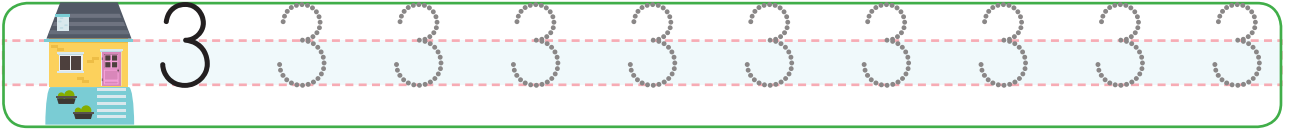

● 3 varlıktan oluşan kutuları işaretleyiniz.

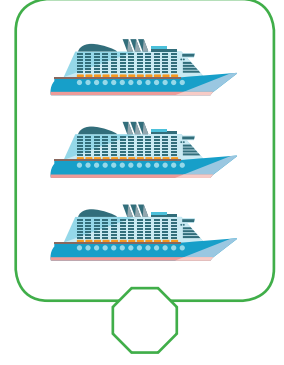
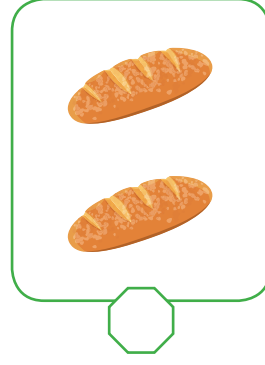
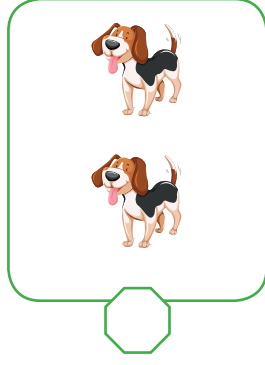
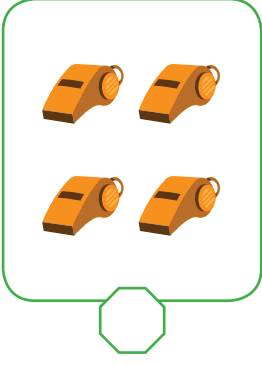

● Aşağıdaki varlıkların 3'er tanesini boyayınız.

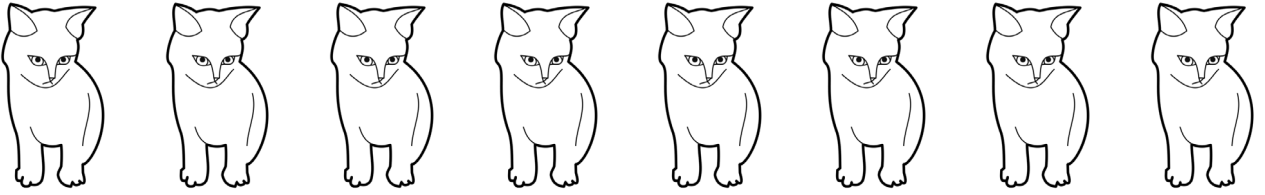
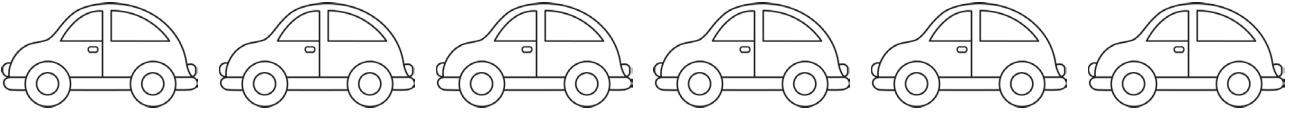

● 3 rakamını yazınız.



SÜPER KAHRAMAN

- Aşağıdaki resmin bölümlerini uygun renklerle boyayınız.

1 Açık Yeşil

2 Koyu Yeşil

3 Siyah

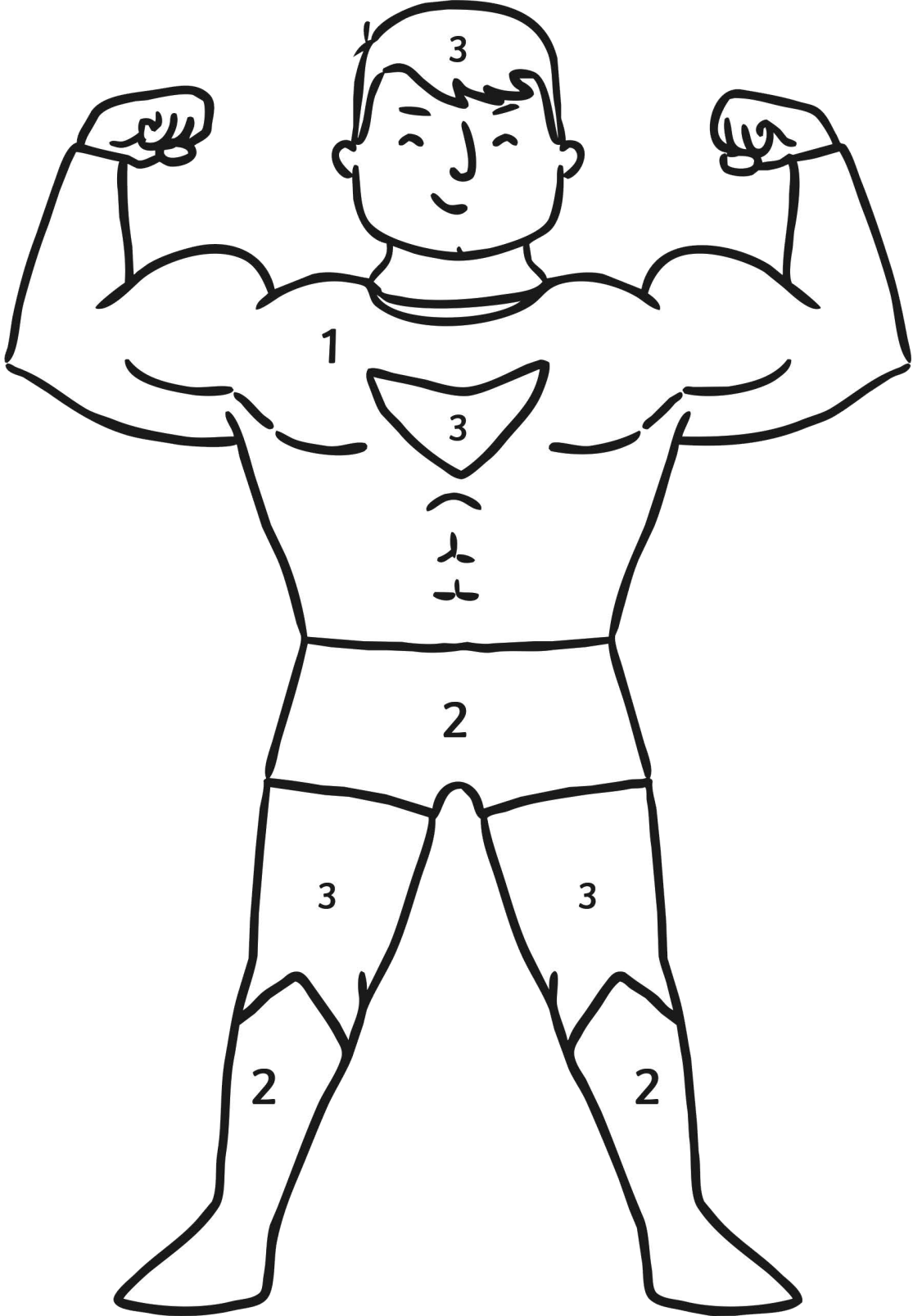

ETKİNLİK ZAMANI

- Aşağıdaki gruplardaki varlıkları sayıp eşleştiriniz.

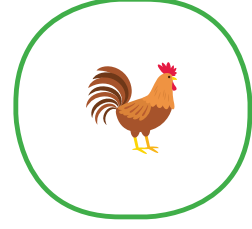

- Aşağıda noktalı olarak verilen rakamların üzerinden gidiniz. Ardından satırları tamamlayınız.

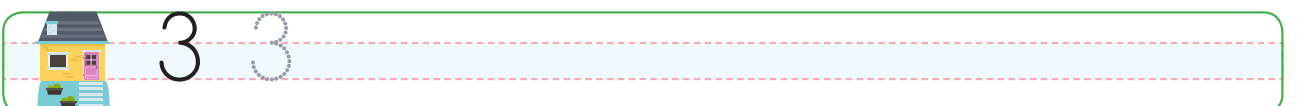
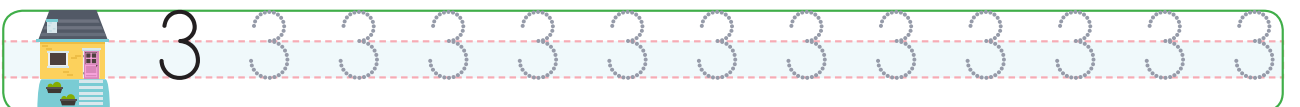
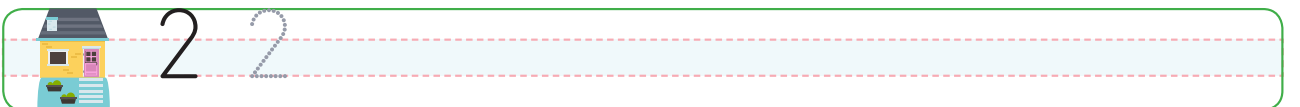

4 RAKAMI

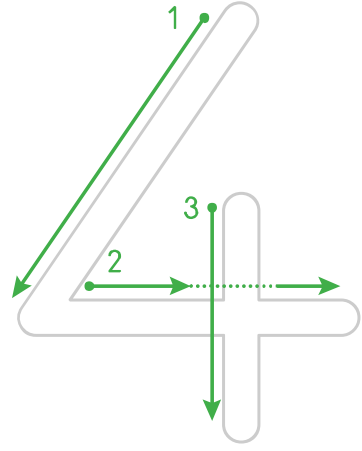
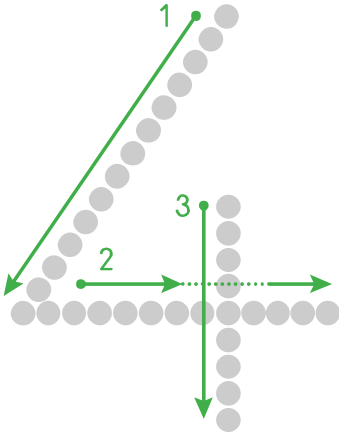

● 4 rakamını yazınız.

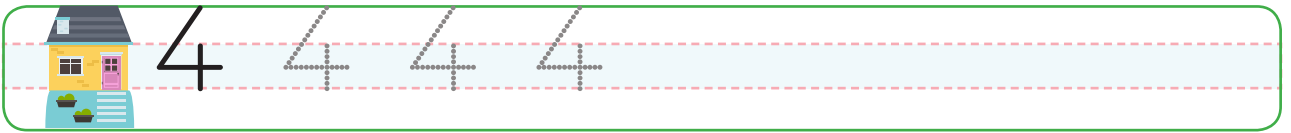
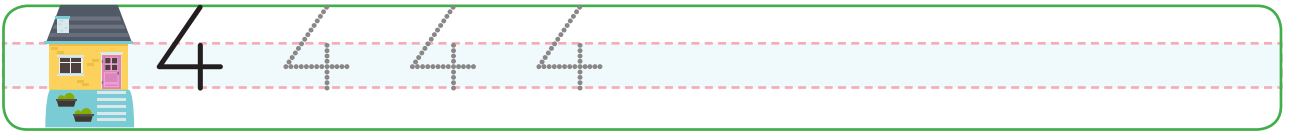
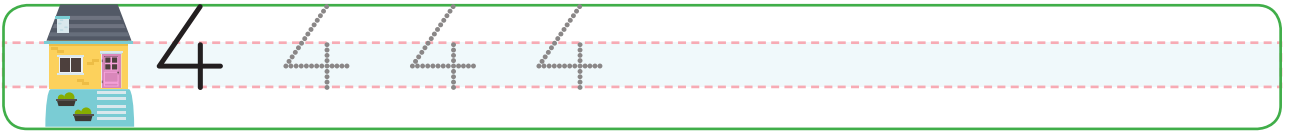
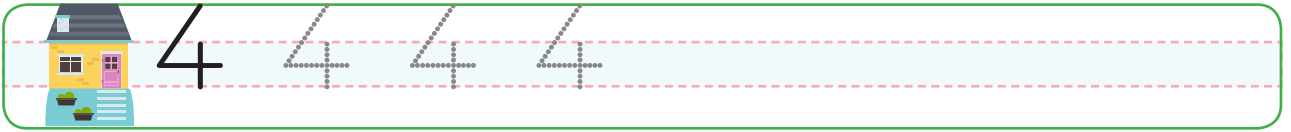
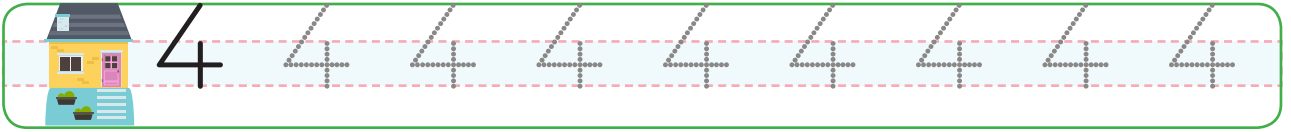
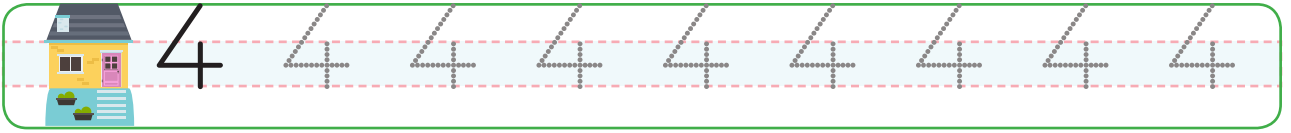
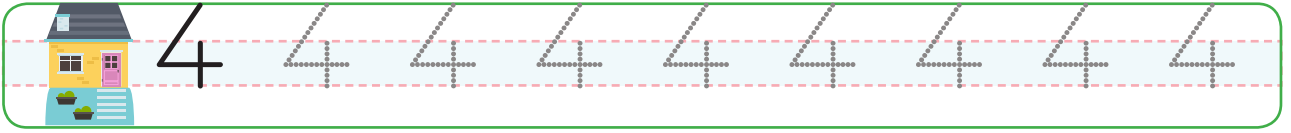
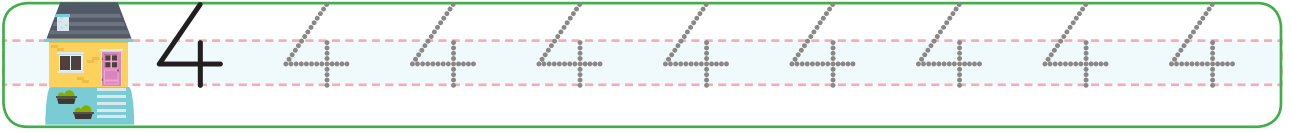

● 4 varlıktan oluşan kutuları işaretleyiniz.

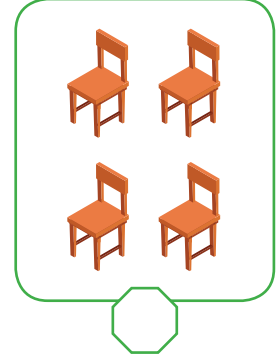
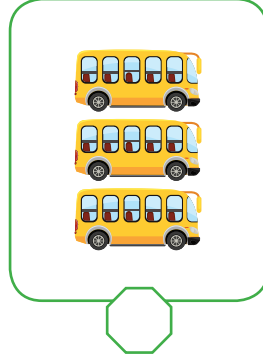
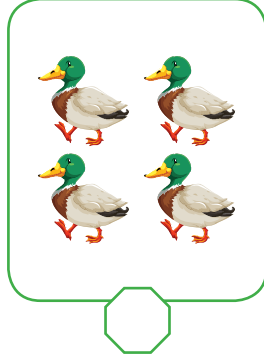
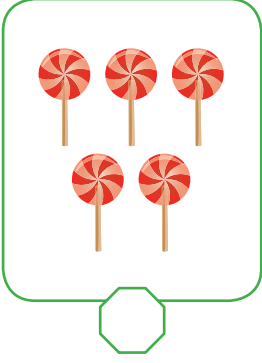

● Aşağıdaki varlıkların 4'er tanesini boyayınız.



● 4 rakamını yazınız.

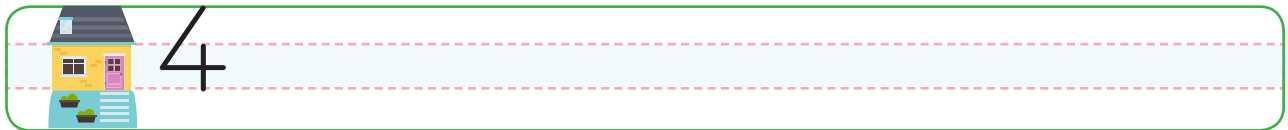
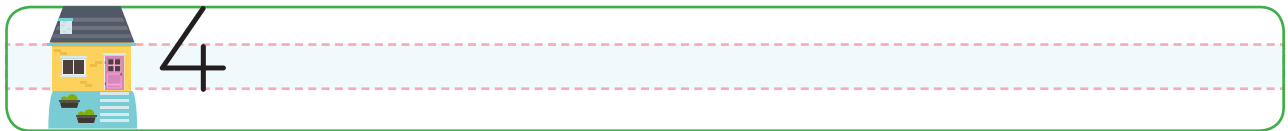
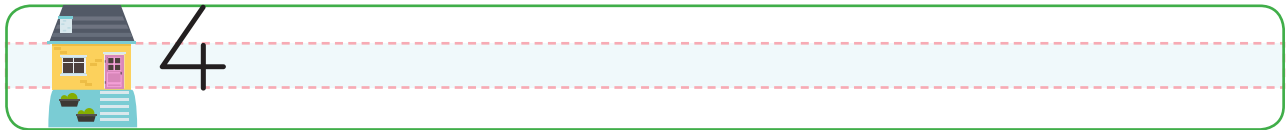

SÜPER KAHRAMAN -2-

- Aşağıdaki resmin bölümlerini uygun renklerle boyayınız.

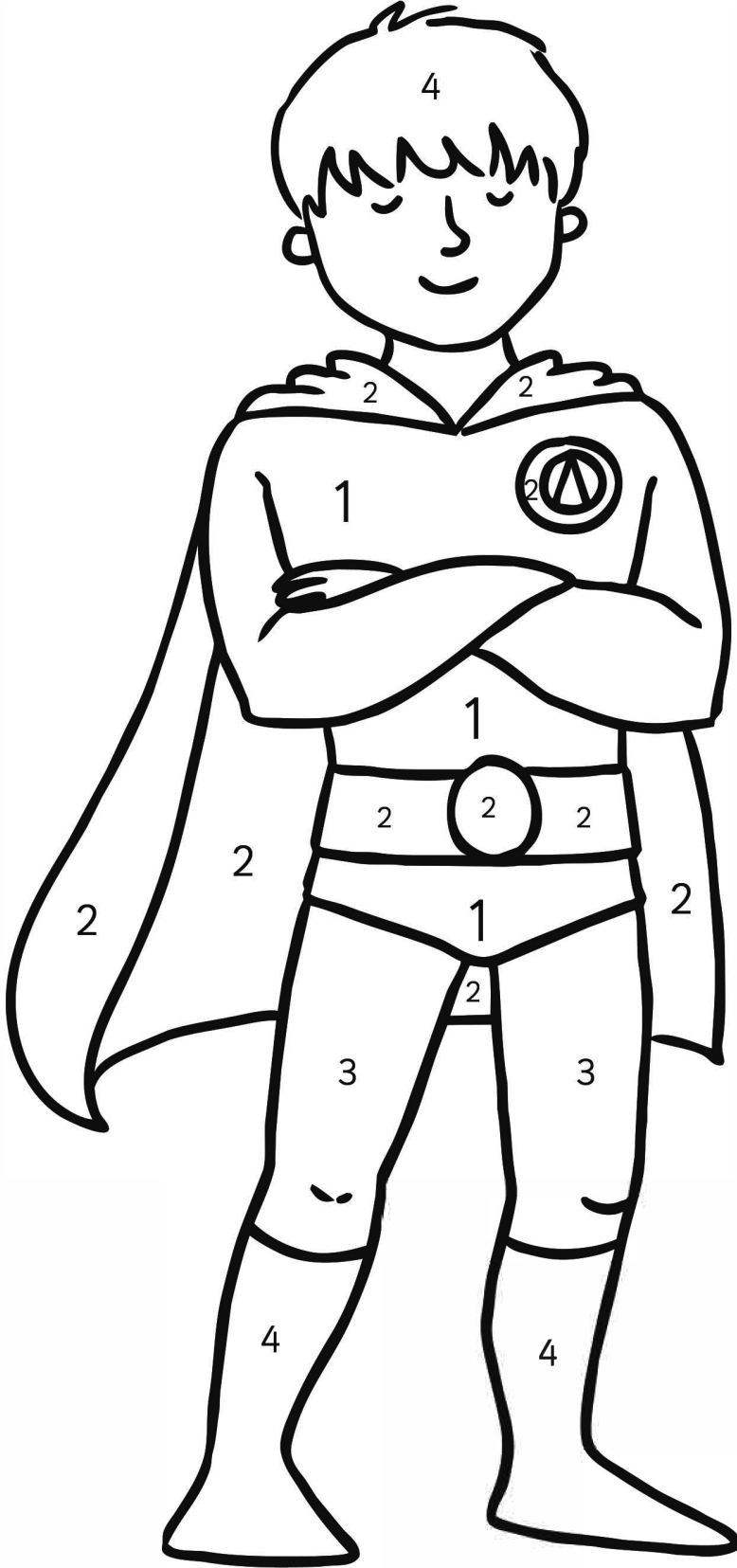

1 Kırmızı

2 Sarı

3 Yeşil

4 Turuncu

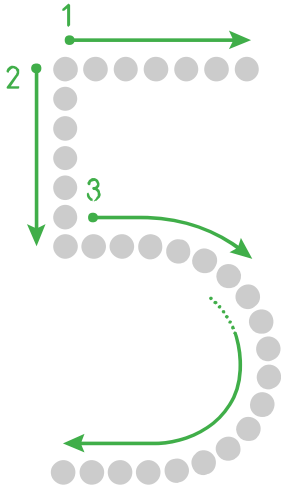

5 RAKAMI

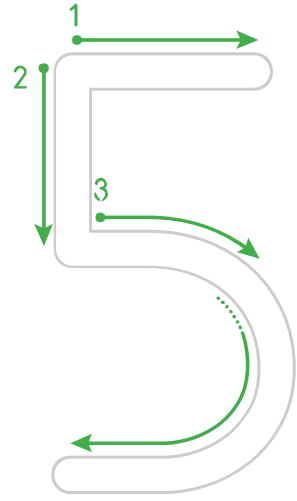

● 5 rakamını yazınız.

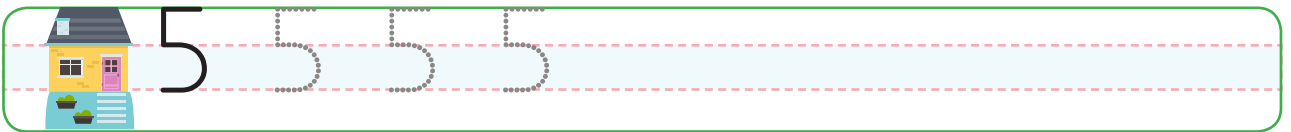
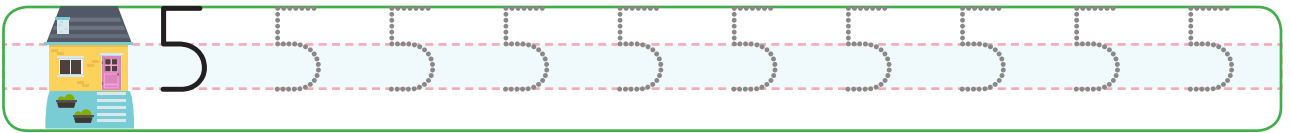
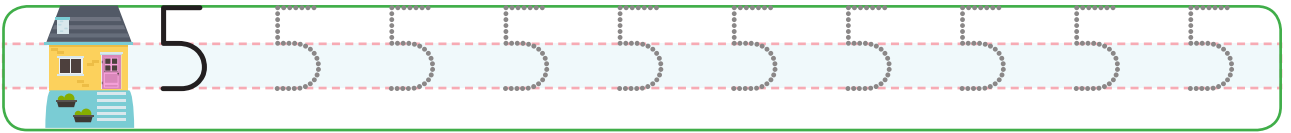
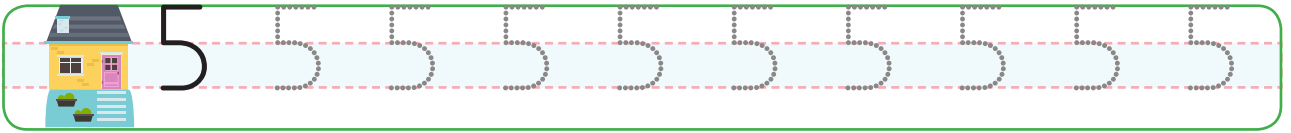
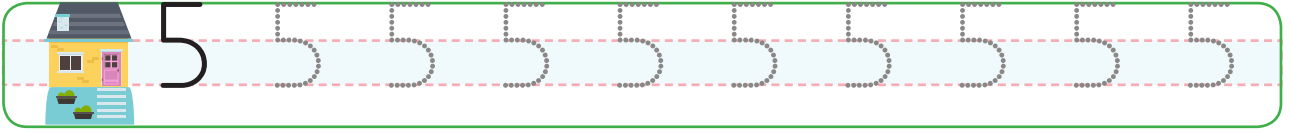

● 5 varlıktan oluşan kutuları işaretleyiniz.

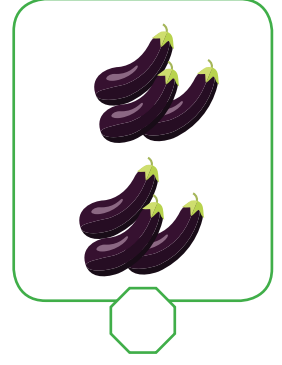
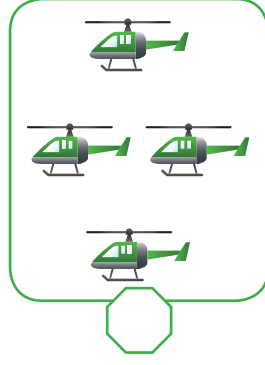
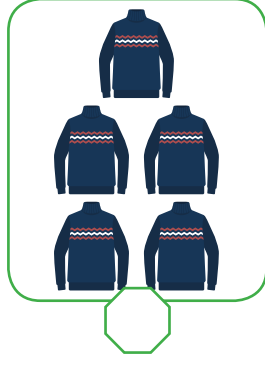
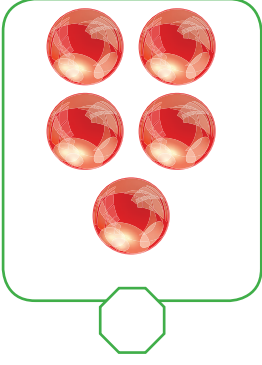

● Aşağıdaki varlıkların 5'er tanesini boyayınız.

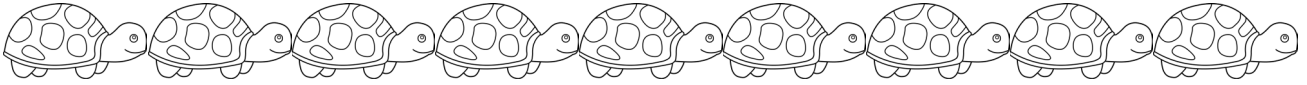
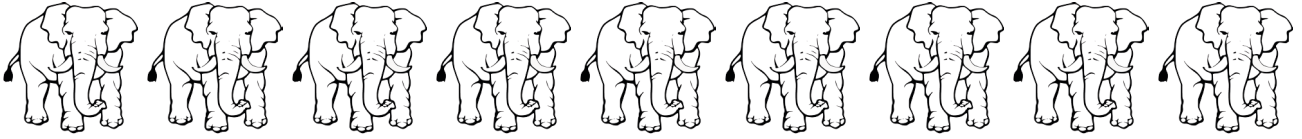
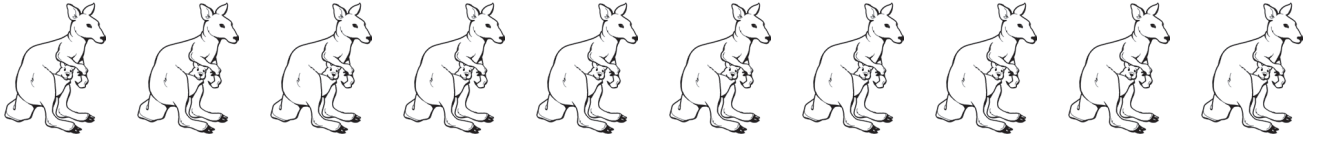

● 5 rakamını yazınız.

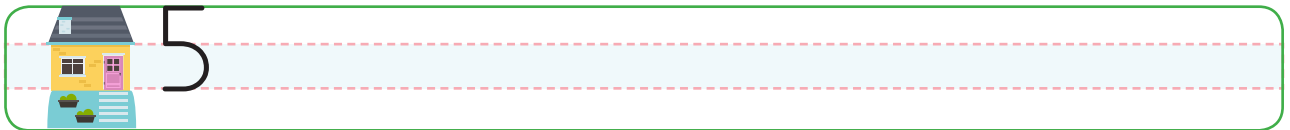
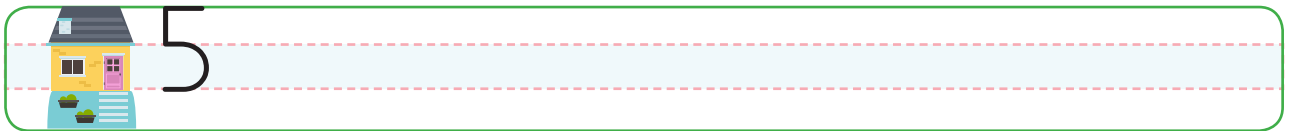
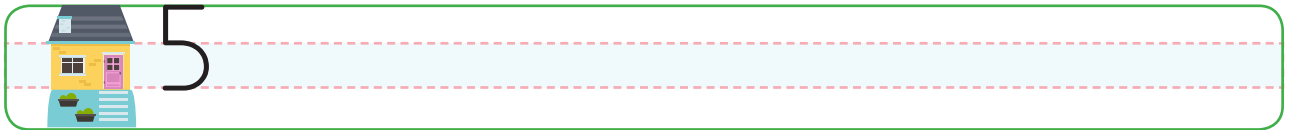

"5" AVCISI

- Aşağıdaki görselde "5" rakamını ifade eden görselleri veya sayıları bulup yuvarlak içine alınız.

5

6

8

5

3

1

5

ETKİNLİK ZAMANI

● Aşağıdaki ayıcığın üzerindeki sayıların olduğu alanları uygun renklerle boyayınız.

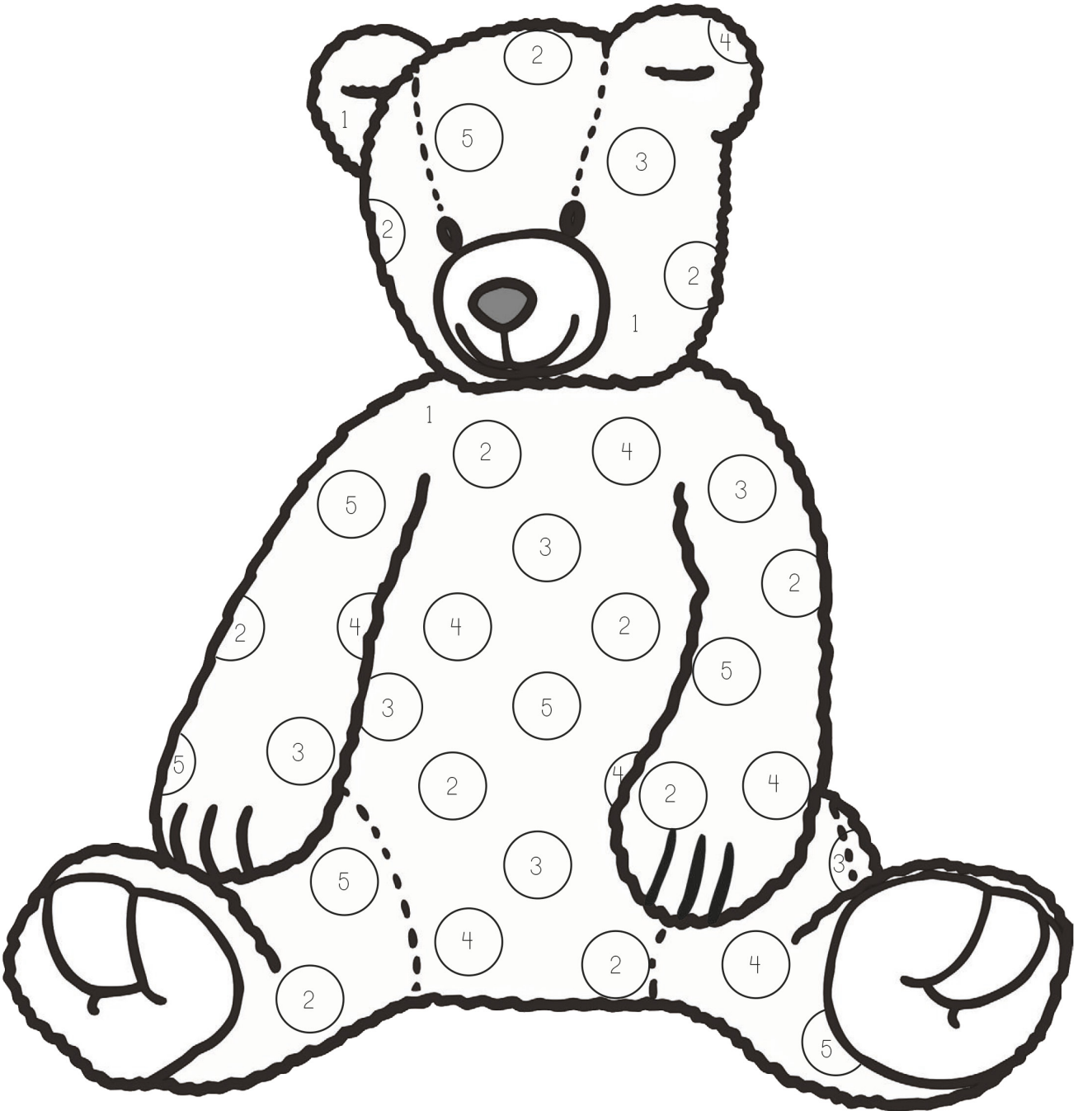

6 RAKAMI

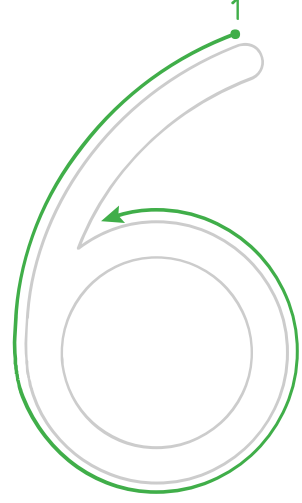
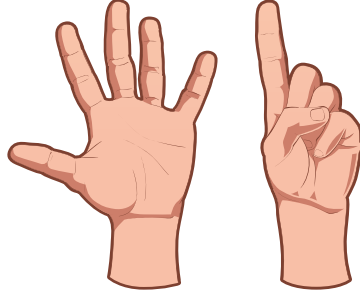
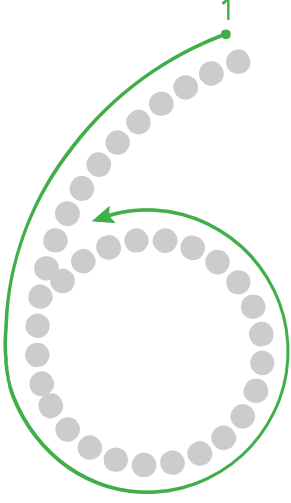

● 6 rakamını yazınız.

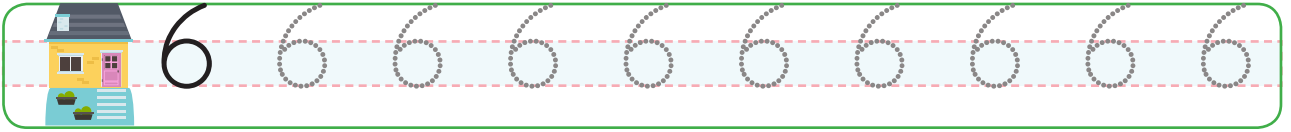
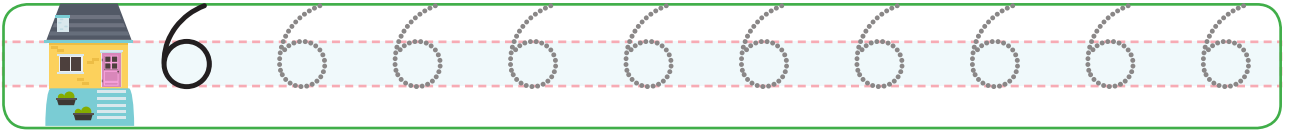
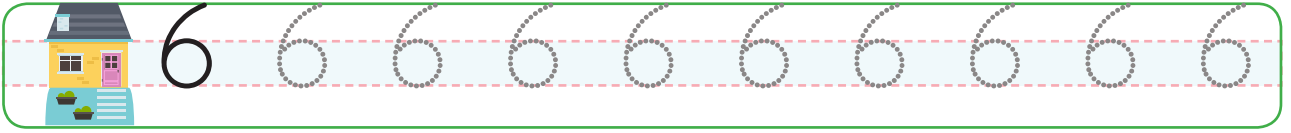
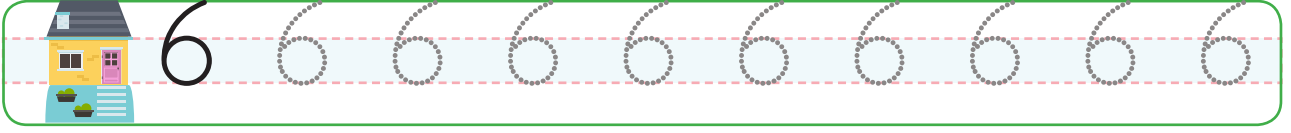

● 6 varlıktan oluşan kutuları işaretleyiniz.

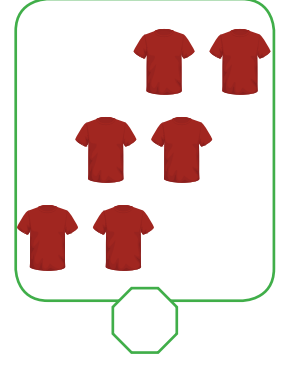
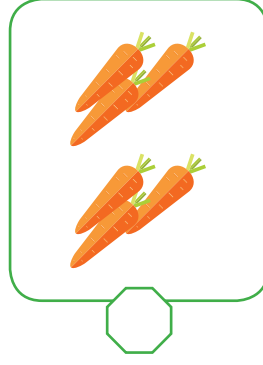
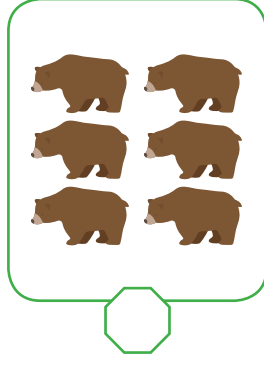
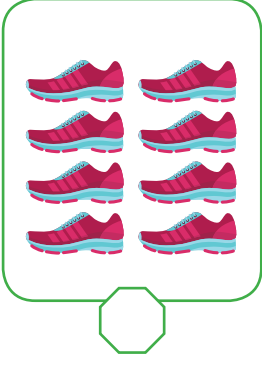

● Aşağıdaki varlıkların 6'sar tanesini boyayınız.

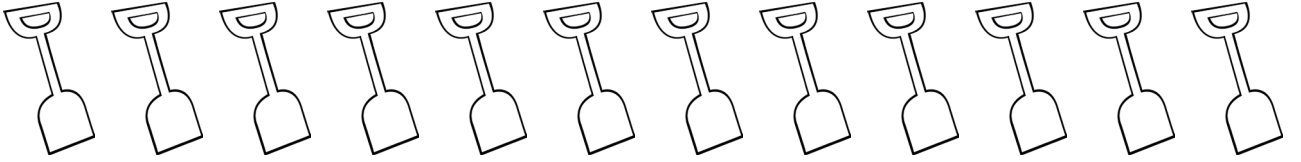

● 6 rakamını yazınız.



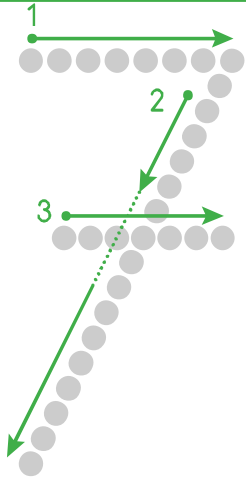

7 RAKAMI

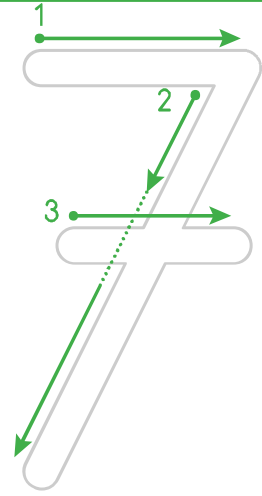
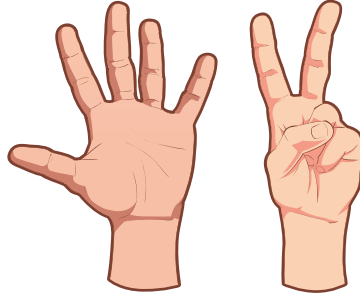

● 7 rakamını yazınız.

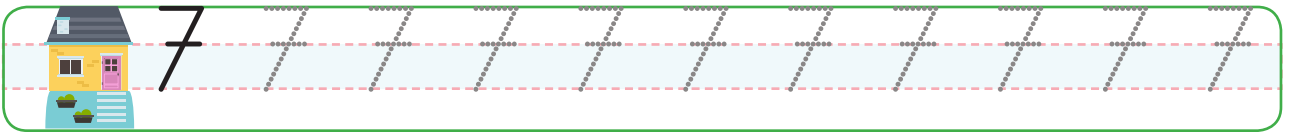
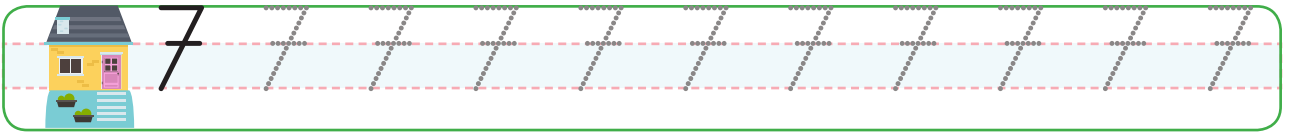
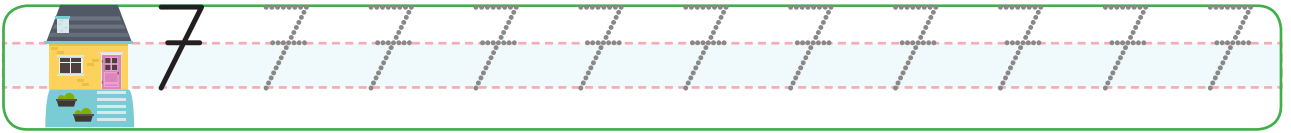
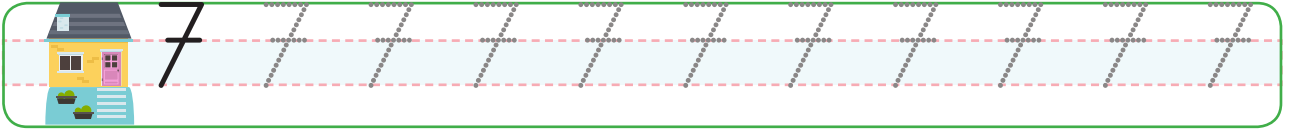

● 7 varlıktan oluşan kutuları işaretleyiniz.

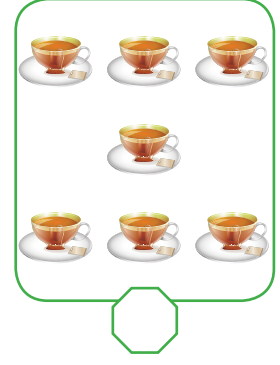
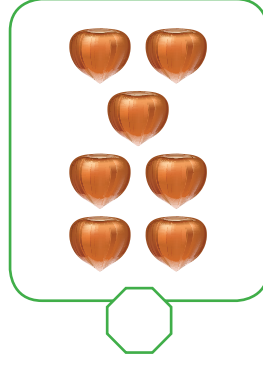
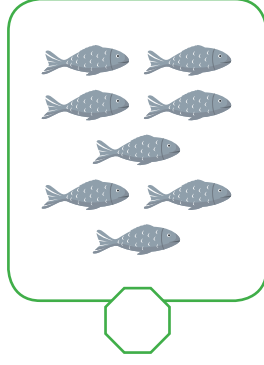
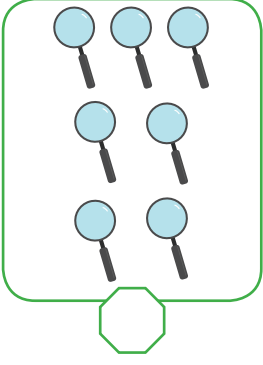

● Aşağıdaki varlıkların 7'şer tanesini boyayınız.

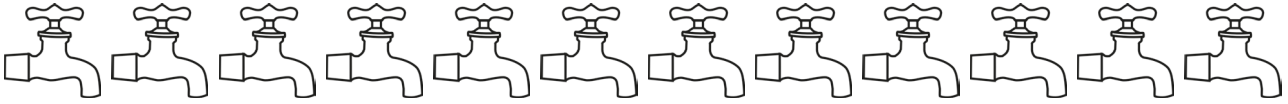
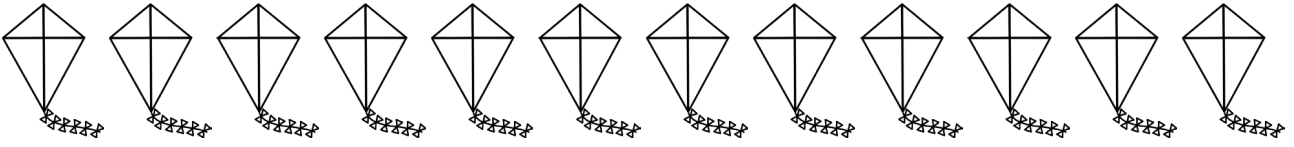

● 7 rakamını yazınız.

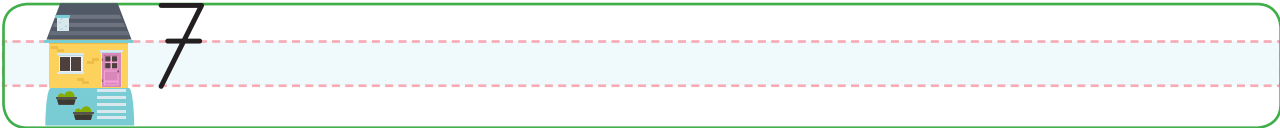

8 RAKAMI

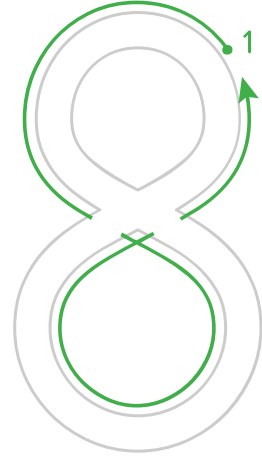
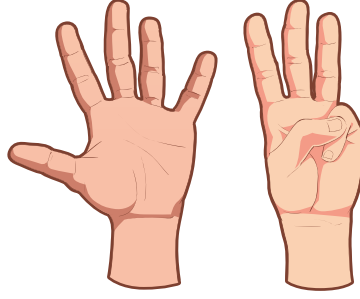
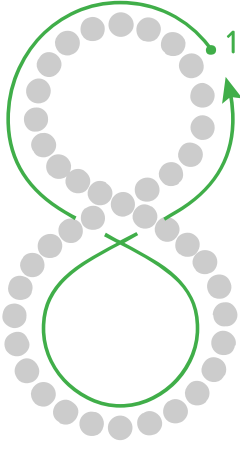

● 8 rakamını yazınız.

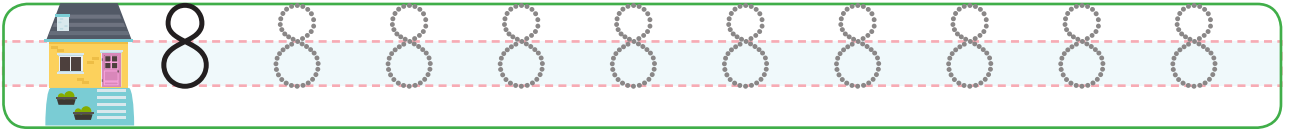
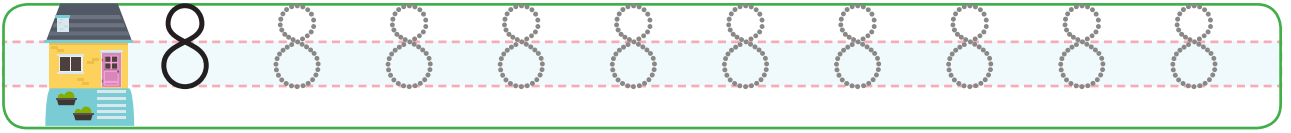
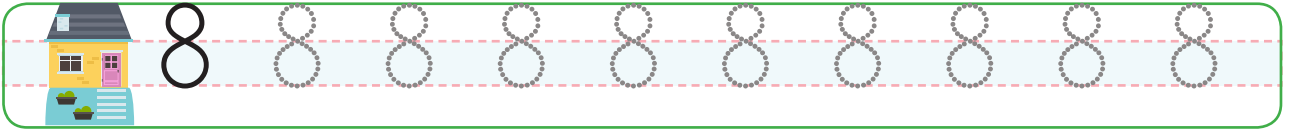
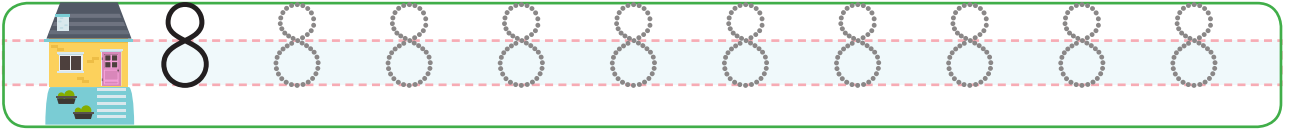

● 8 varlıktan oluşan kutuları işaretleyiniz.

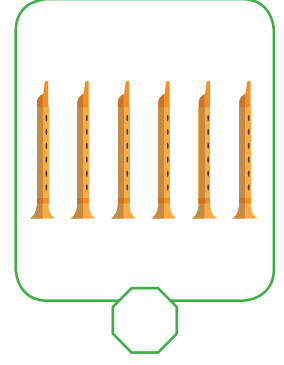
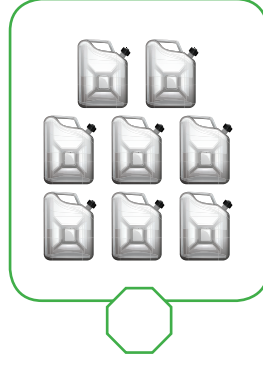
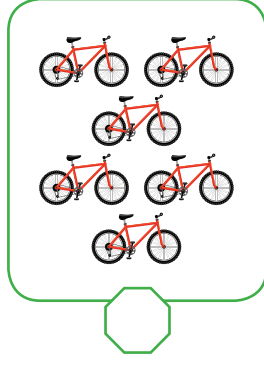
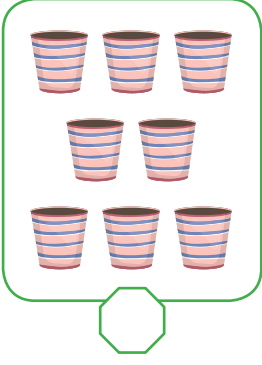

● Aşağıdaki varlıkların 8'er tanesini boyayınız.

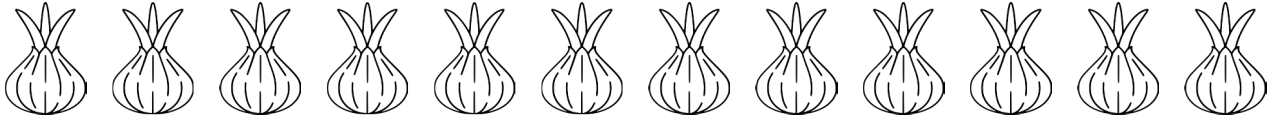
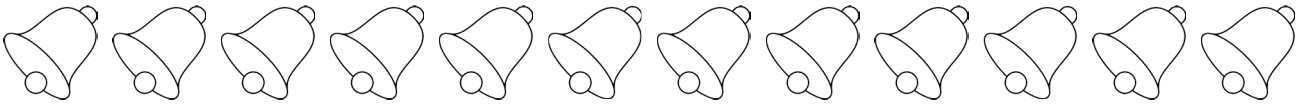
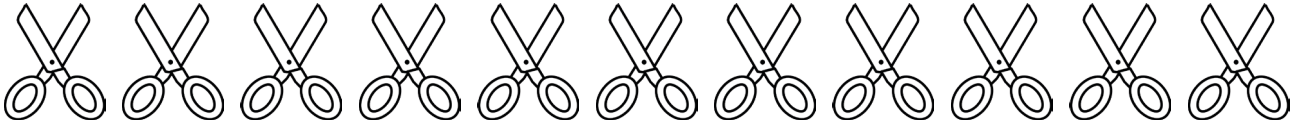

● 8 rakamını yazınız.

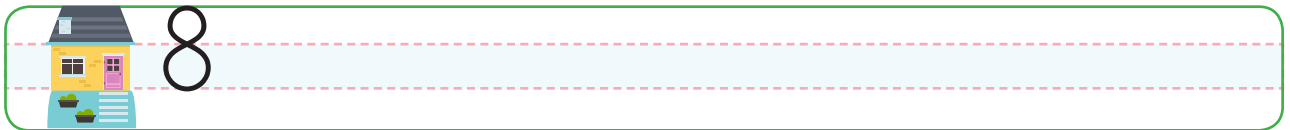
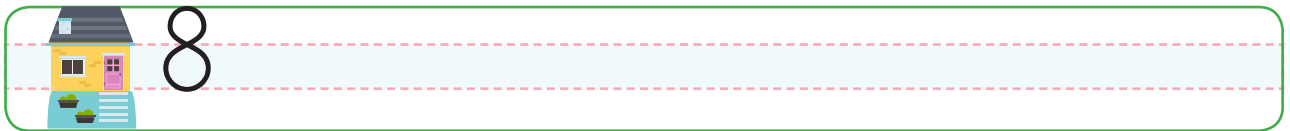

9 RAKAMI

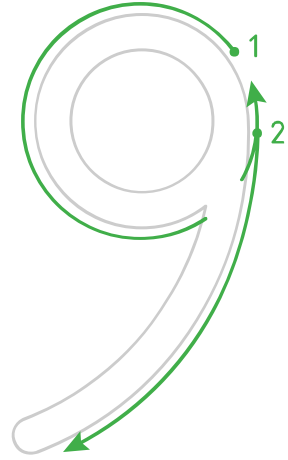
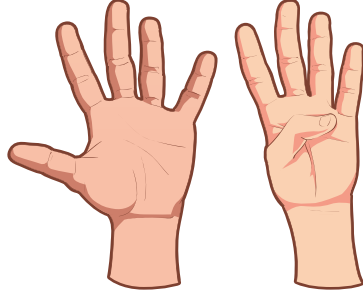
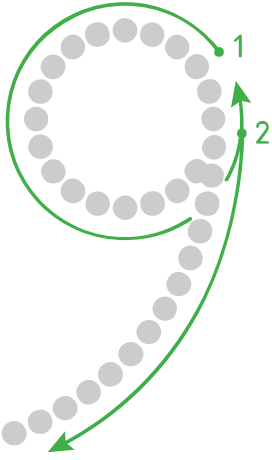

● 9 rakamını yazınız.

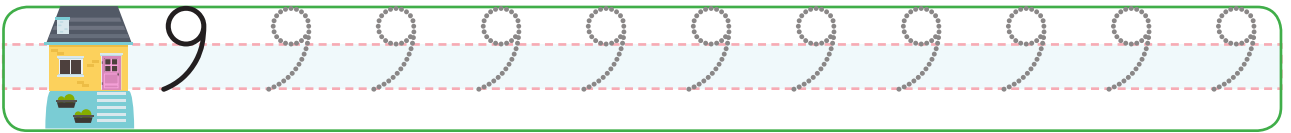
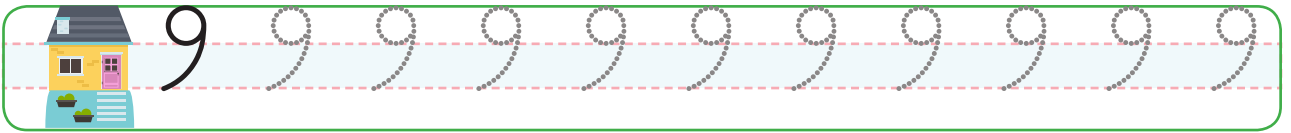
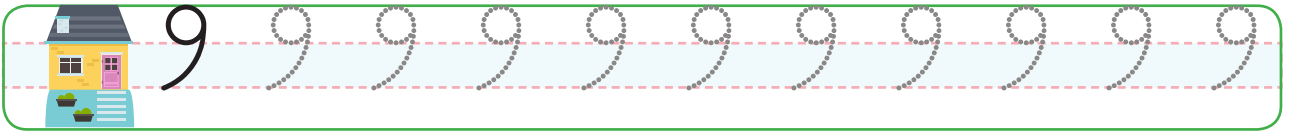
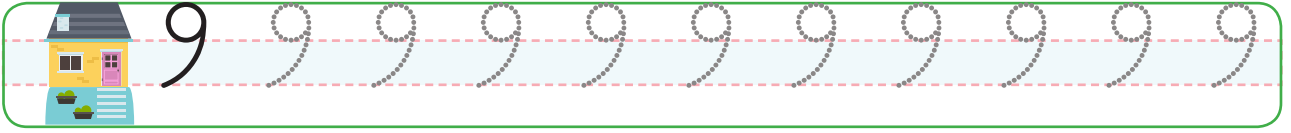

● 9 varlıktan oluşan kutuları işaretleyiniz.

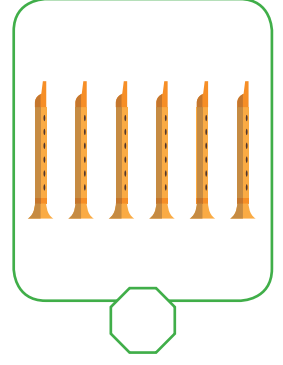
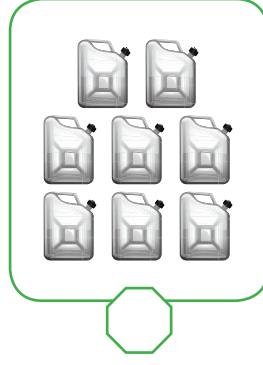
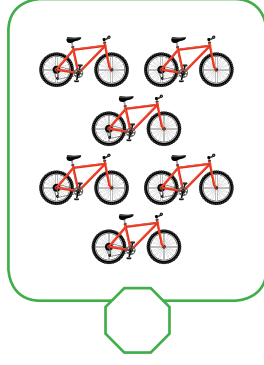
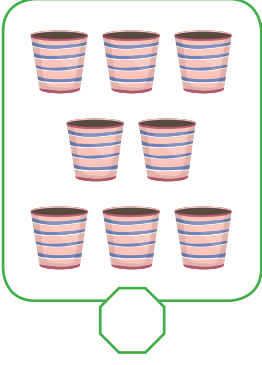

● Aşağıdaki varlıkların 9'ar tanesini boyayınız.

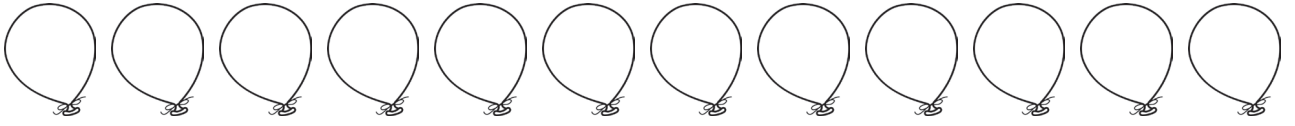

● 9 rakamını yazınız.



0 RAKAMI

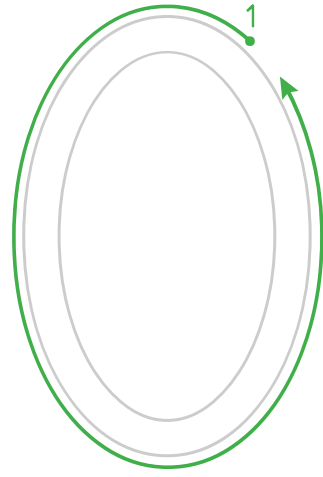
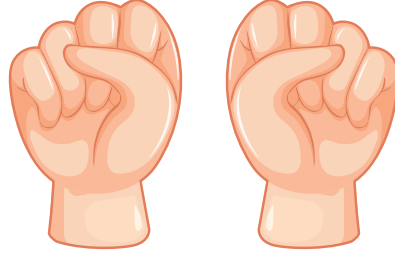
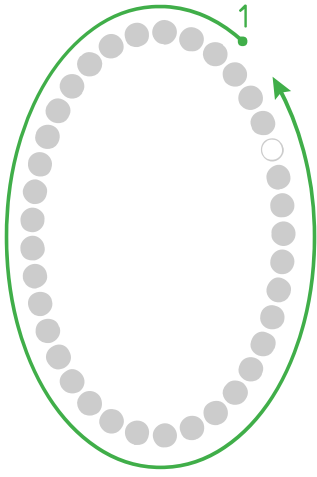

● 0 rakamını yazınız.

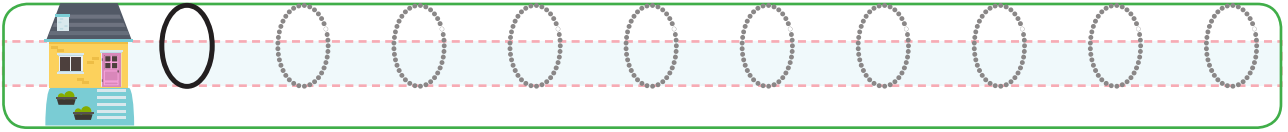
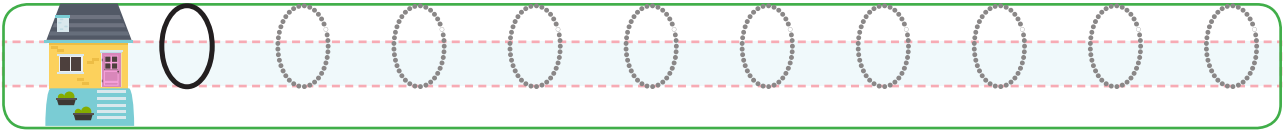
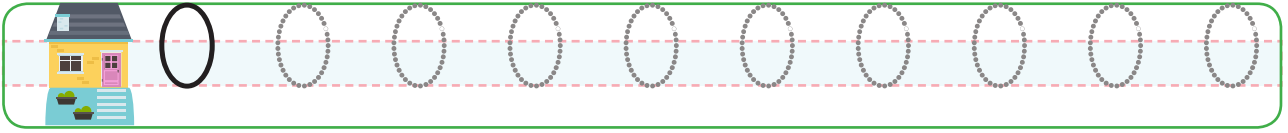
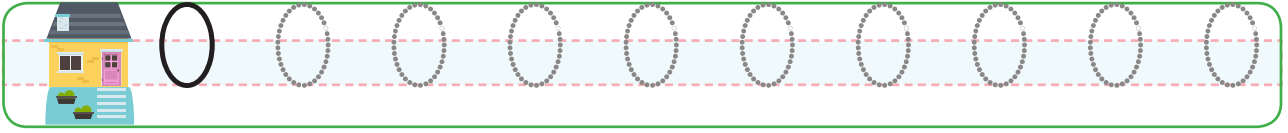

● 0 varlıktan oluşan kutuları işaretleyiniz.

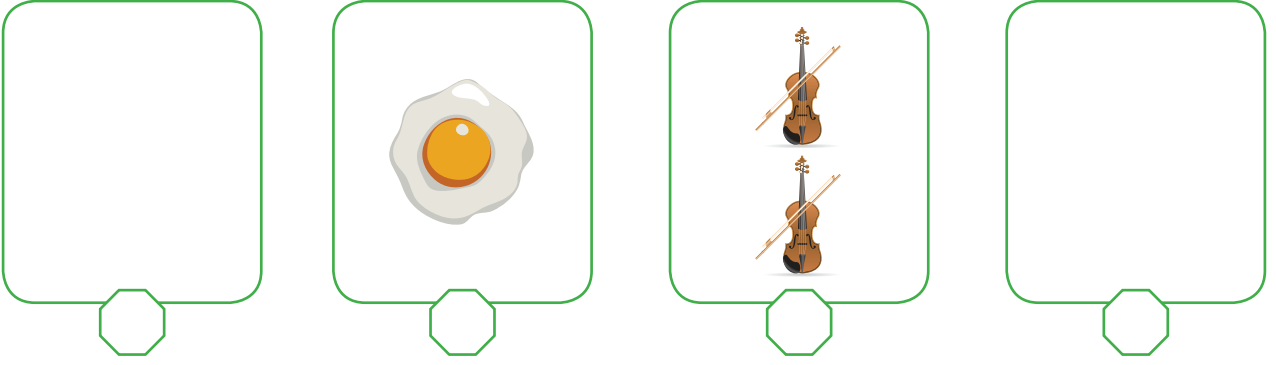

● Aşağıdaki varlıkların 0 tanesini boyayınız.

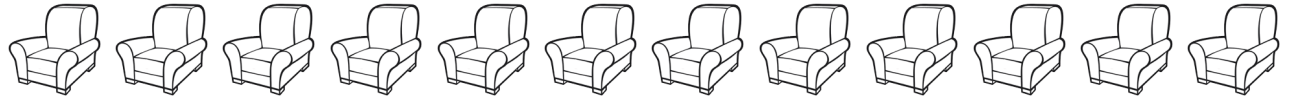
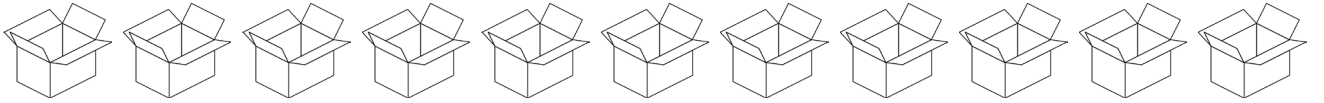
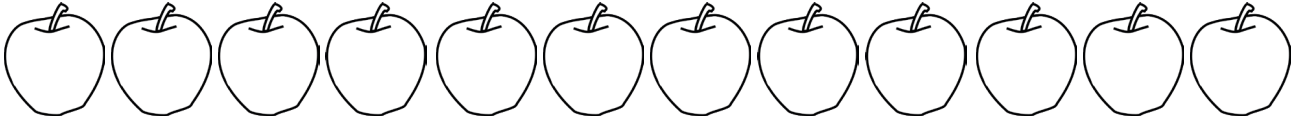

● 0 rakamını yazınız.



ETKİNLİK ZAMANI

- Aşağıdaki satırları tamamlayınız.

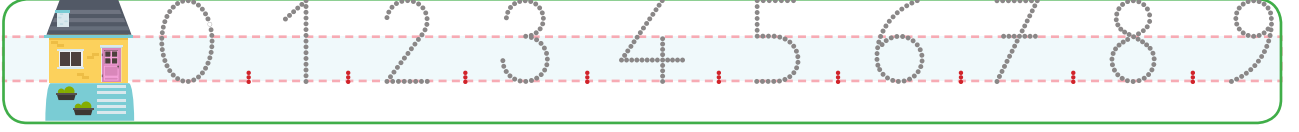

- Gruplarda bulunan varlıkları sayıp yazınız.

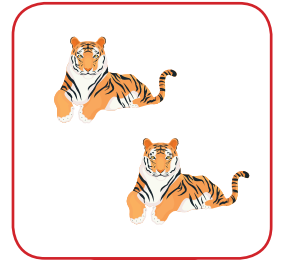
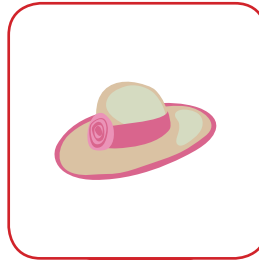
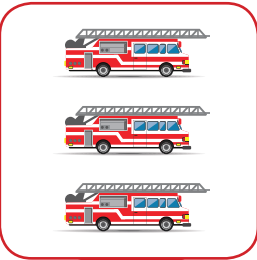
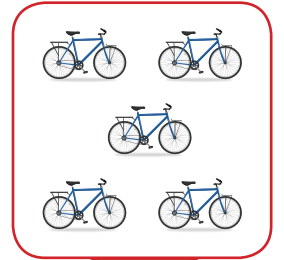
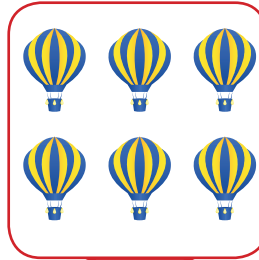
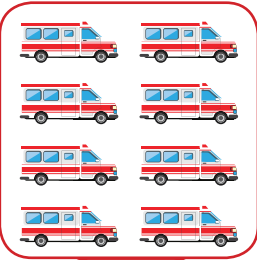

ETKİNLİK ZAMANI

- Aşağıdaki yumurtanın üzerindeki sayıların olduğu alanları uygun renklerle boyayınız.

6 Kırmızı

7 Sarı

8 Mavi

9 Mor

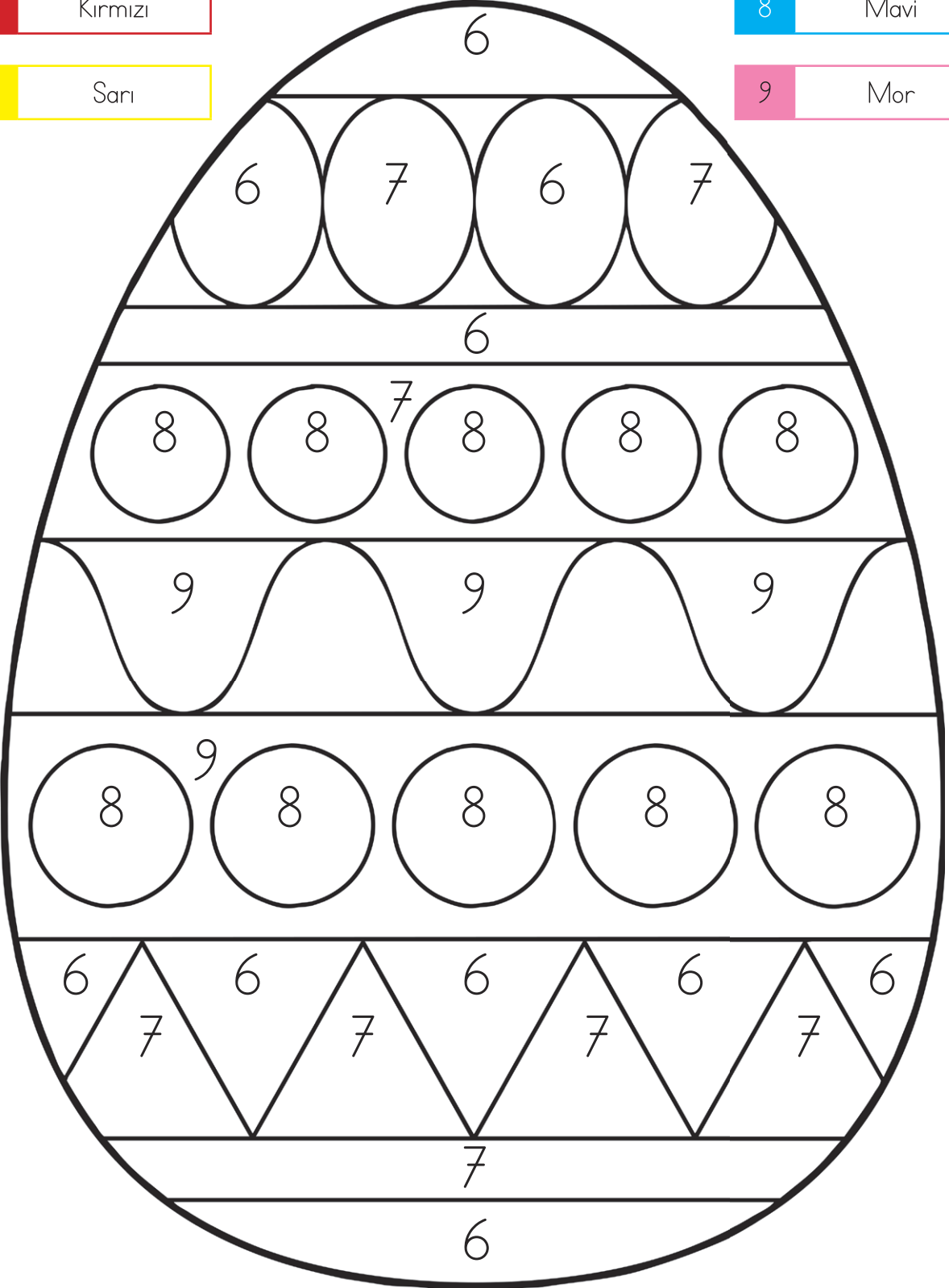

ETKİNLİK ZAMANI

- Aşağıdaki bulutların üzerinde yazan sayı kadar damlacık boyayınız.



ETKİNLİK ZAMANI

● Aşağıdaki filin üzerindeki sayıların olduğu alanları uygun renklerle boyayınız.

