

✓ Resimde gördüklerimizi anlatalım.

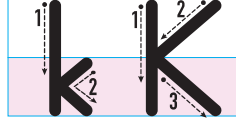

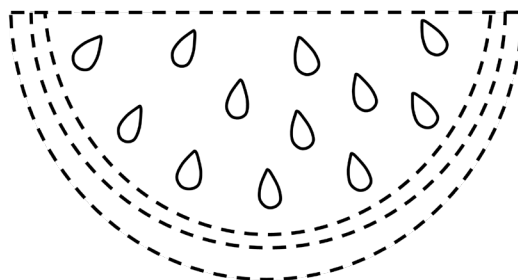

✓ Adında "k" sesi olan görsellerdeki noktaları birleştirip görseli boyayalım.

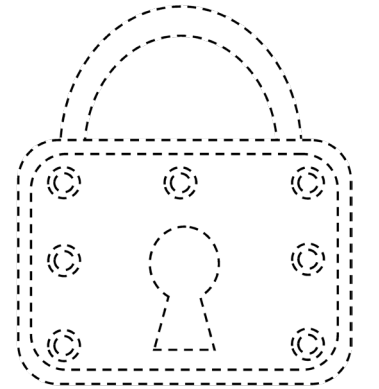
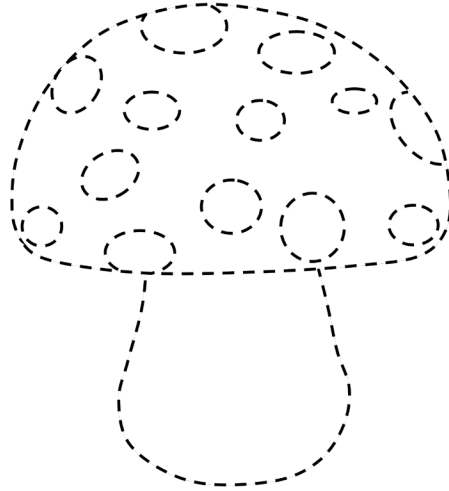
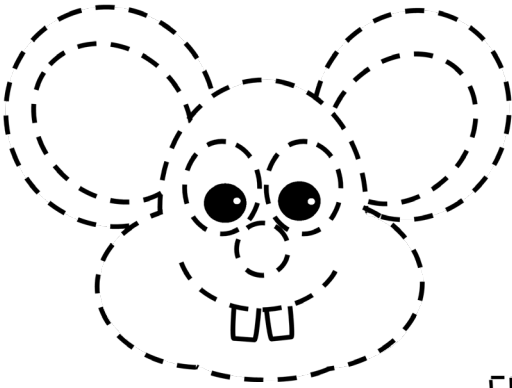
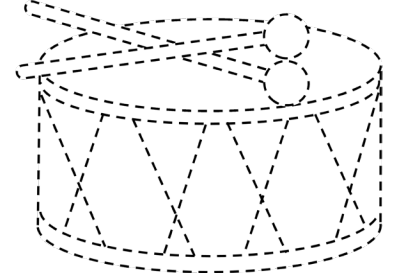
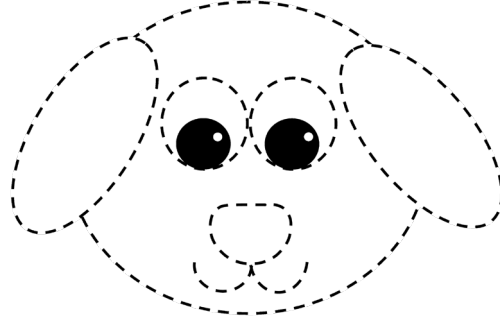
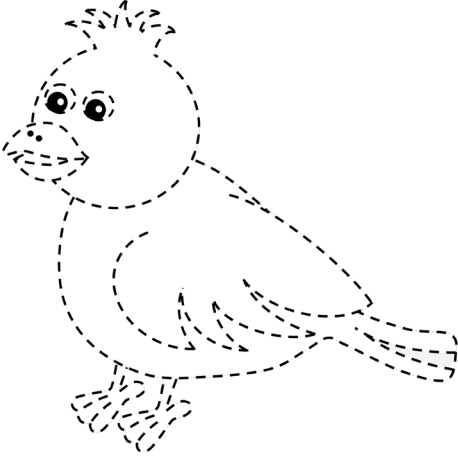
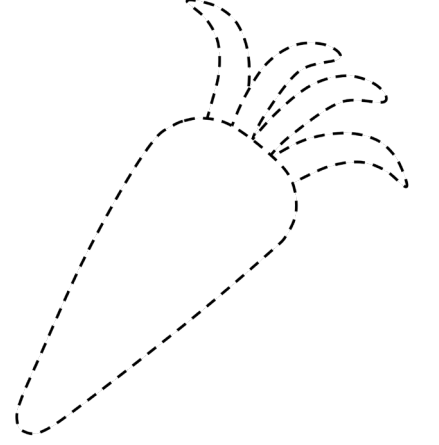
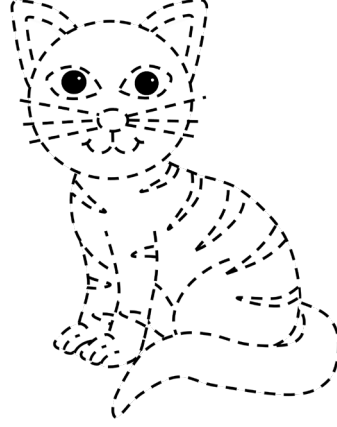
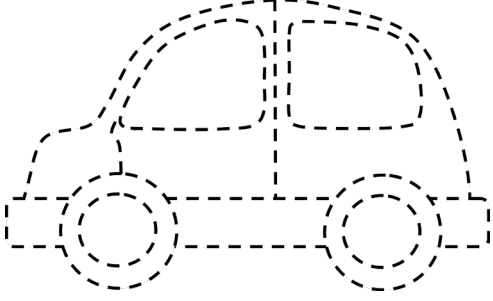

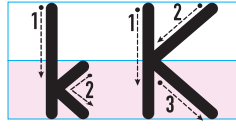

✓ Adında "k" sesi olan varlıkları işaretleyelim.

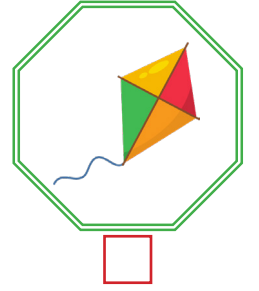
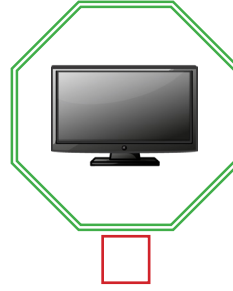
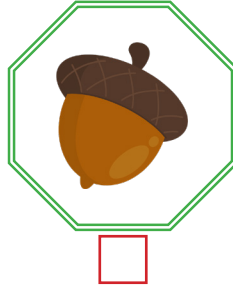
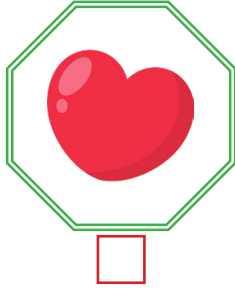
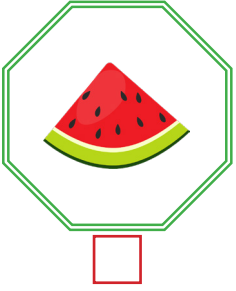
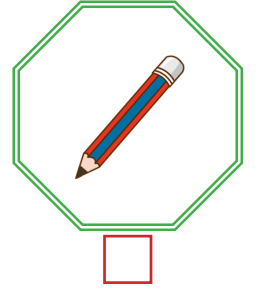
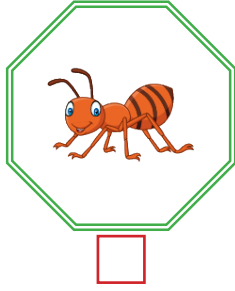
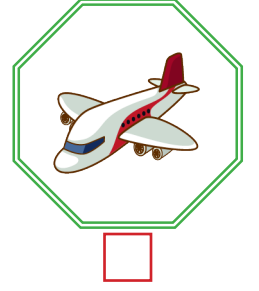
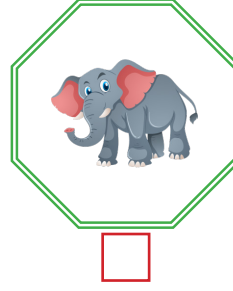
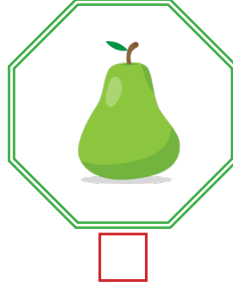
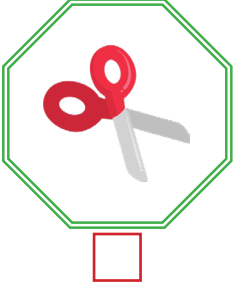

✓ Aşağıdaki görsellerin adında bulunan "k" sesi kadar kalp boyyalım.





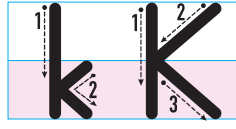

✓ Kalemli kullanarak 1 rakamının bulunduđu yerden başlamak şartıyla ok yönünde "k" harflerini içinden çizerek örnekteki gibi yapalım.

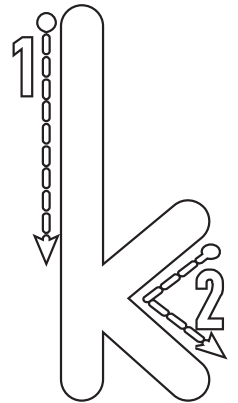
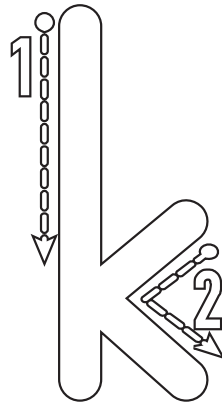
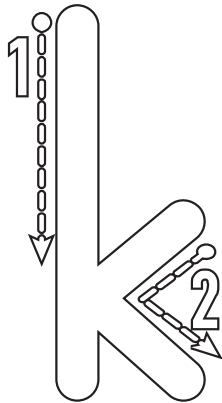
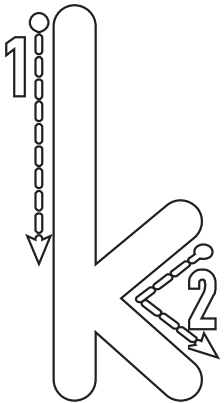
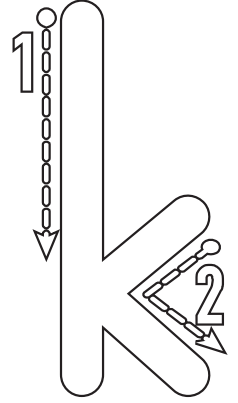
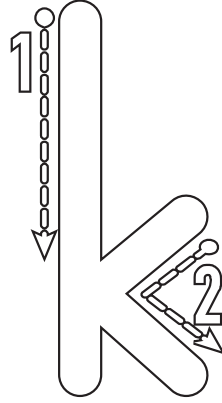
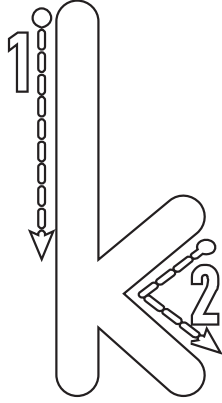
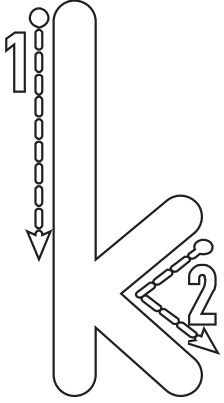
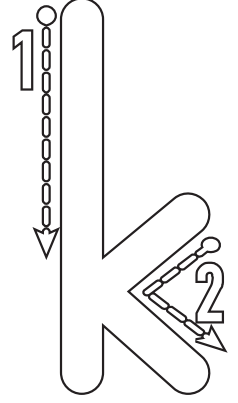
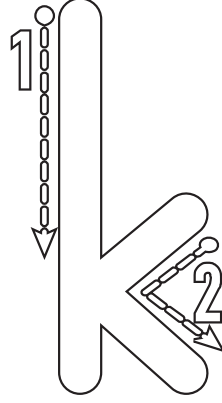
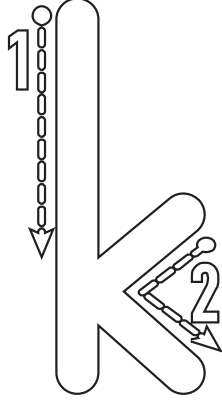
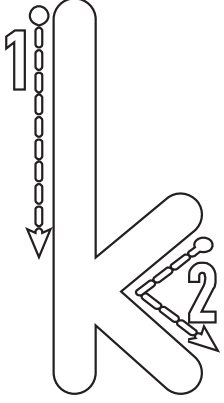
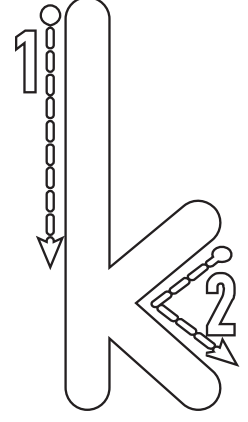
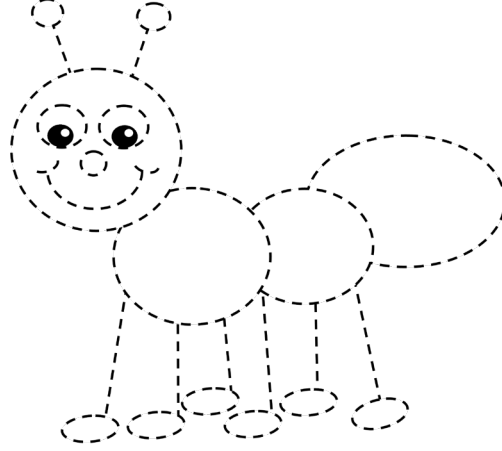
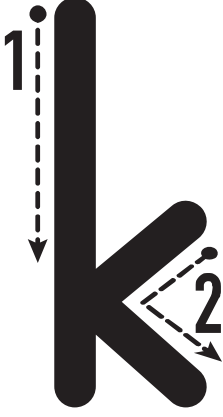

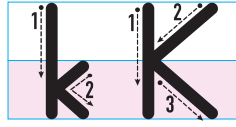

✓ "k" harfini yazalım.

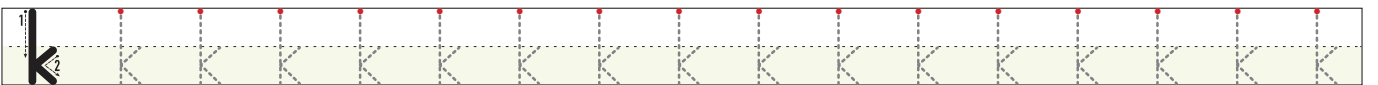
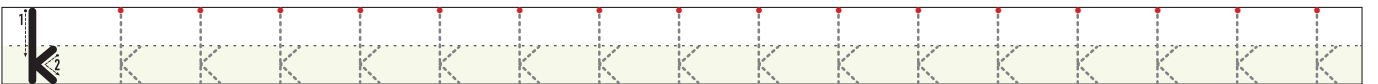
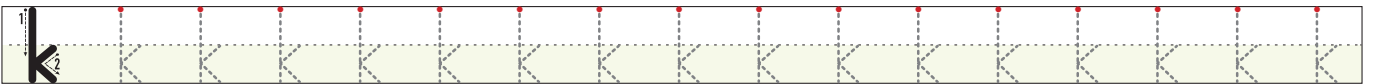
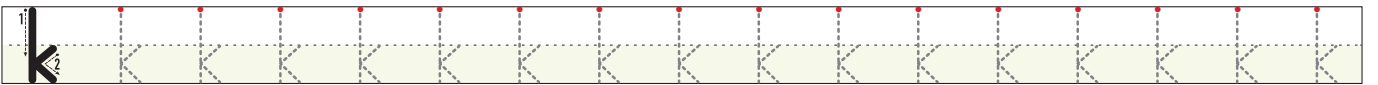
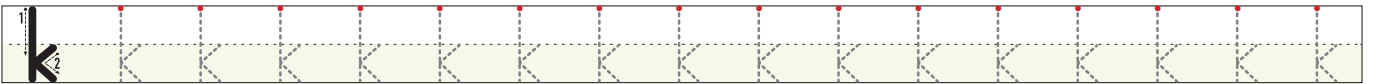
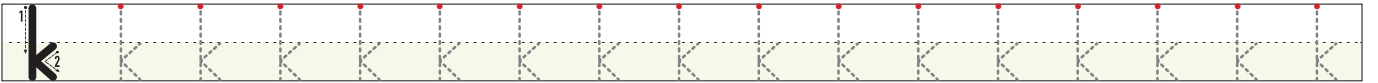
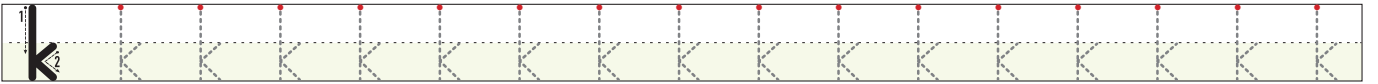
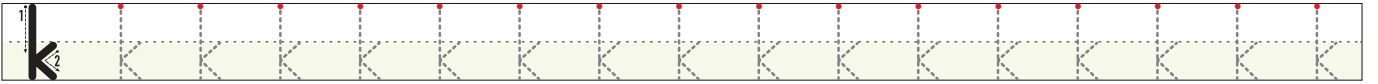
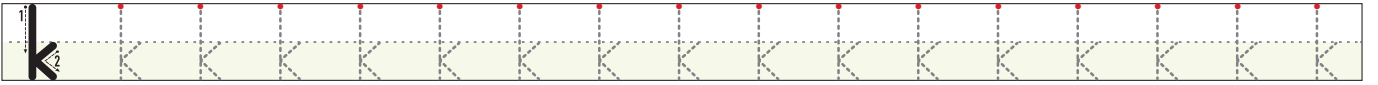
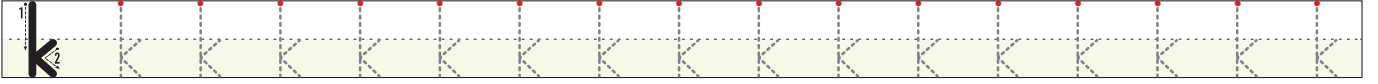
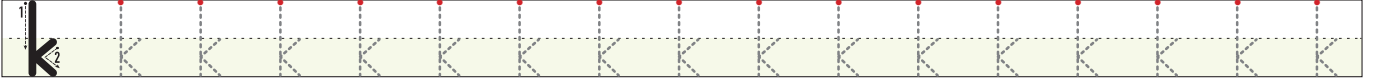
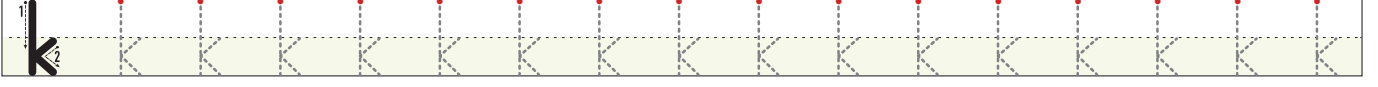

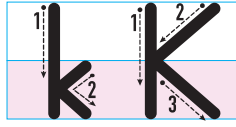

✓ "k" harfini yazalım.

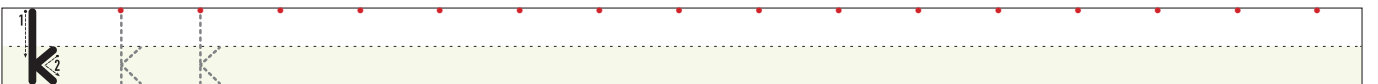
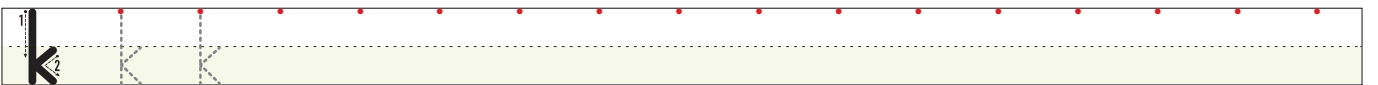
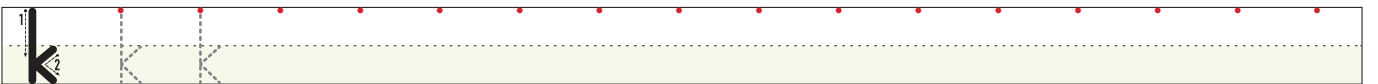
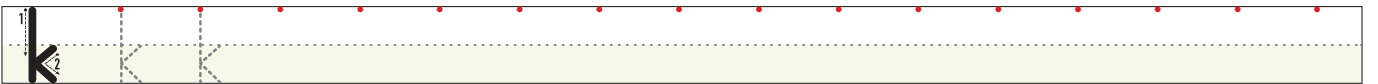
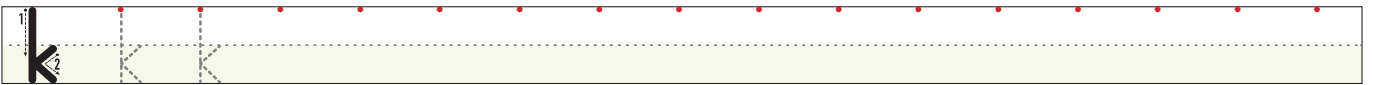
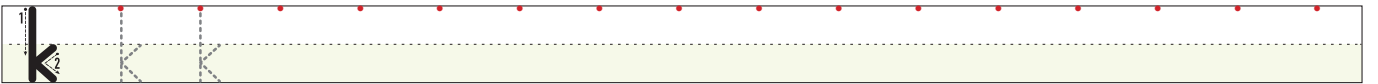
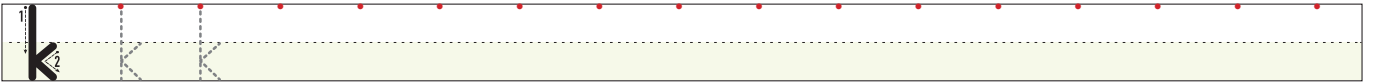
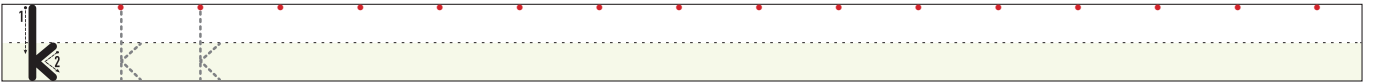
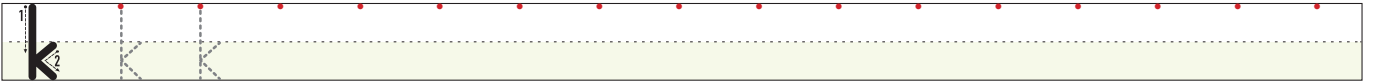
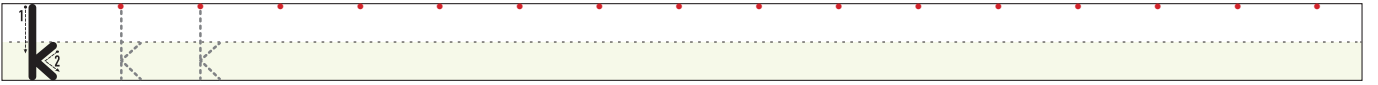
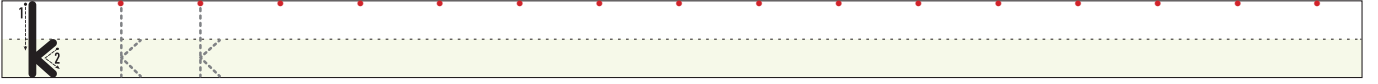

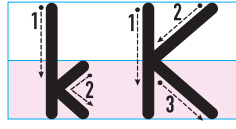

✓ Aşağıdaki satır dizgelerine "k" harfini yazalım.

k k k

k k k

k k k

k k k

k k k

k k k

k k k

k k k

k k k

k k k

k k k

k k k

k k k

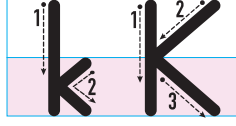

✓ Kalemli kullanarak 1 rakamının bulunduđu yerden başlamak şartıyla ok yönünde "K" harflerini içinden çizerek örnekteki gibi yapalım.

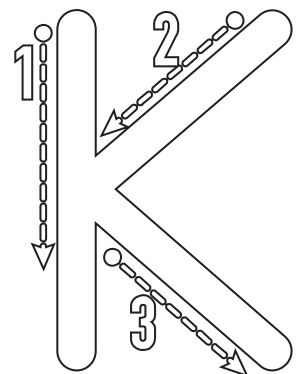
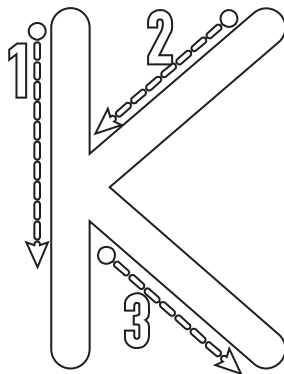
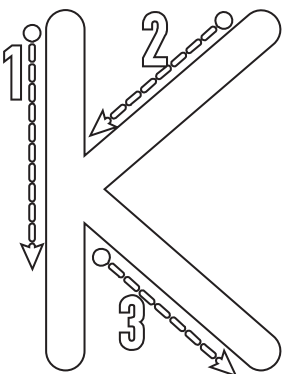
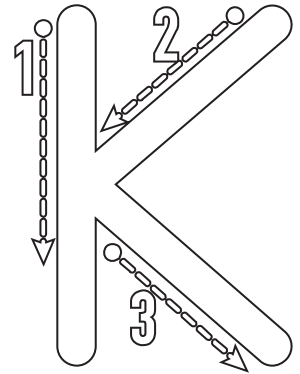
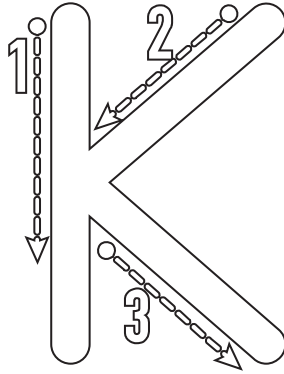
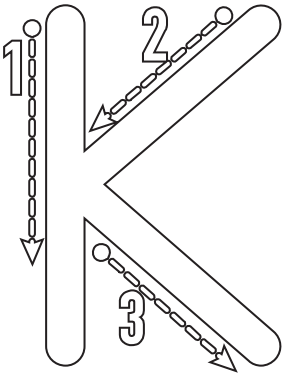
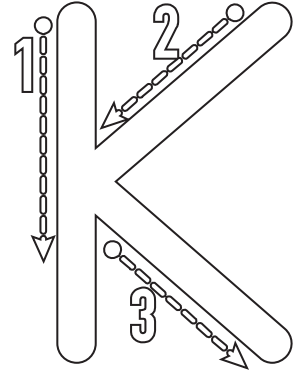
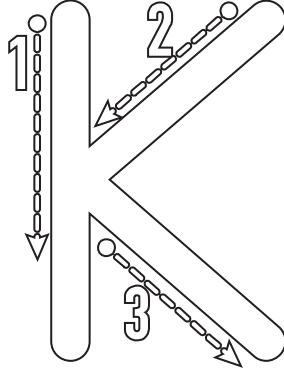
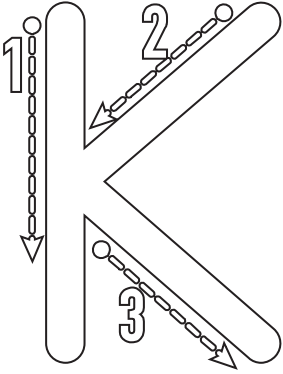
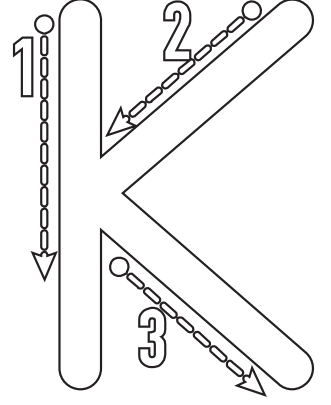
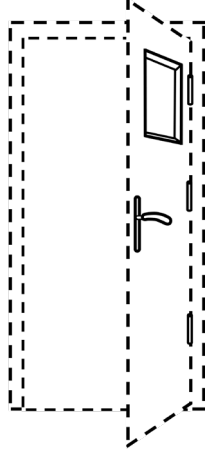
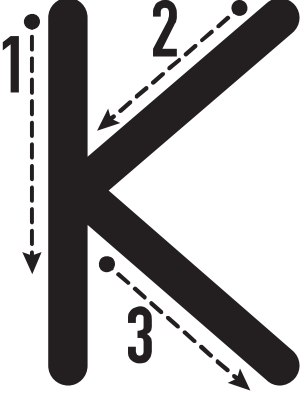

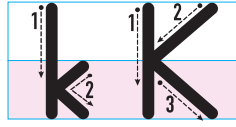

✓ "K" harfini yazalım.

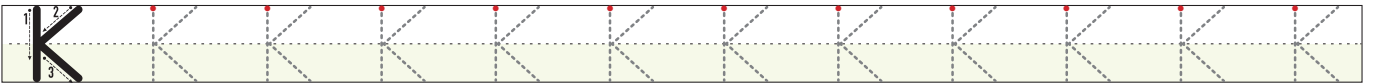
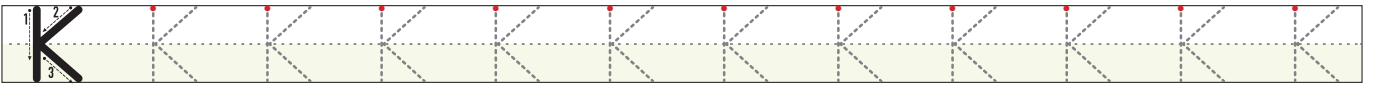
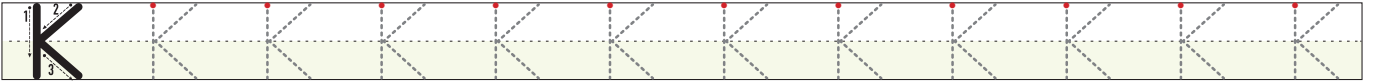

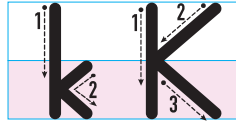

✓ "K" harfini yazalım.

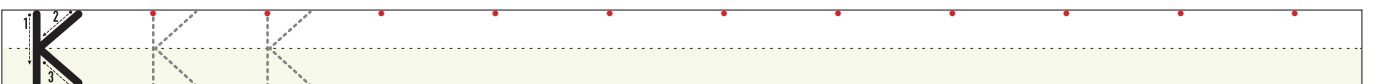
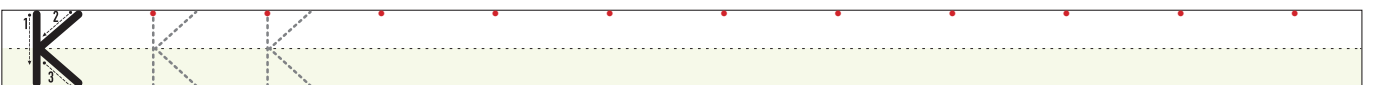
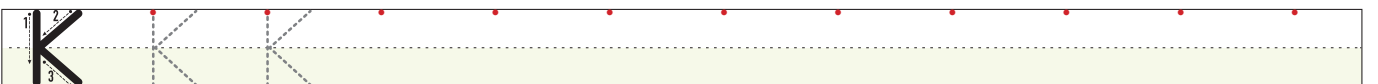
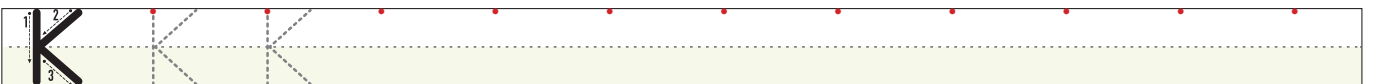
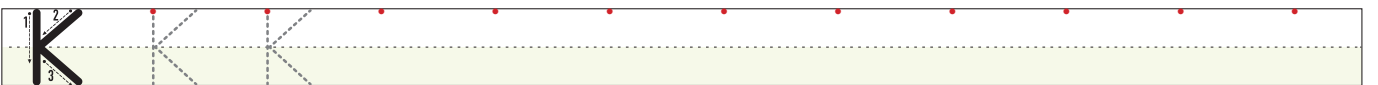
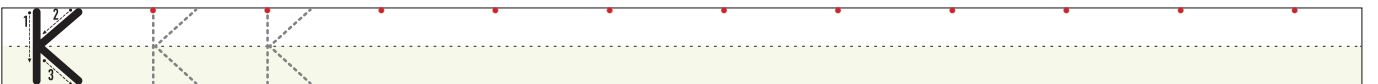
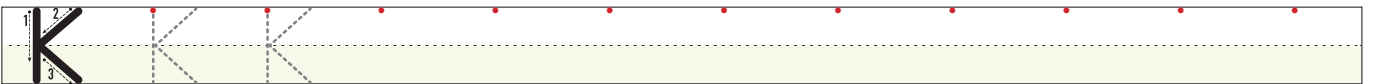
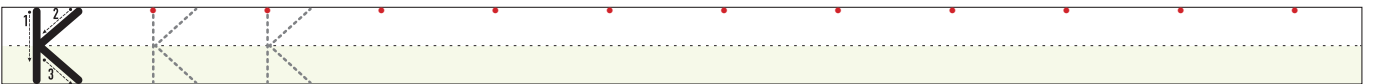
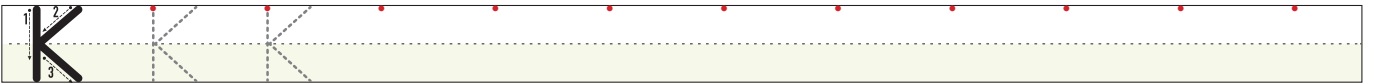
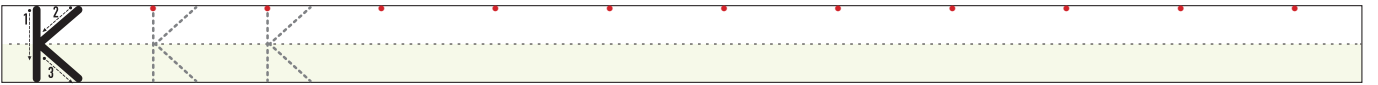
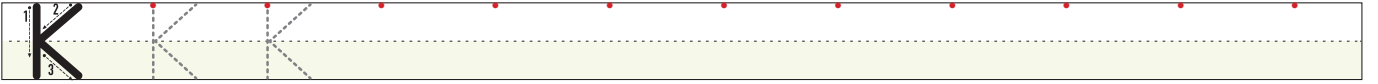
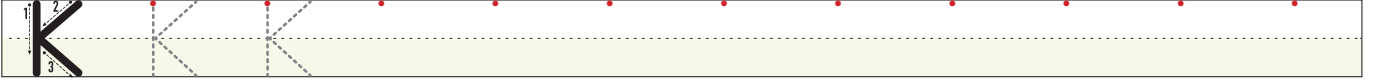

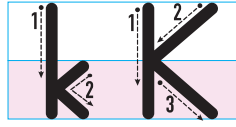

✓ Aşağıdaki satır dizgelerine "K" harfini yazalım.

K K K

K K K

K K K

K K K

K K K

K K K

K K K

K K K

K K K

K K K

K K K

K K K

K K K



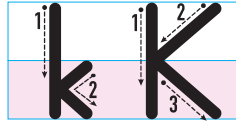

✓ Büyük ve küçük "k" harfini yazalım.

K k K k K k K k K k K k K k K k K k

K k K k

K k K k

K k K k

K k K k

K k K k

K k K k

K k K k

K k K k

K k K k

K k K k

K k K k

K k K k

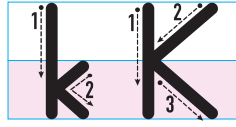

✓ Önce okuyalım, sonra yazalım.

a k  
ak

ak ak ak ak ak ak ak ak  
ak ak

e k  
ek

ek ek ek ek ek ek ek ek  
ek ek

i k  
ik

ik ik ik ik ik ik ik ik ik ik  
ik ik

o k  
ok

ok ok ok ok ok ok ok ok ok ok  
ok ok

k a  
ka

ka ka ka ka ka ka ka ka ka  
ka ka

k e  
ke

ke ke ke ke ke ke ke ke ke  
ke ke

k i  
ki

ki ki ki ki ki ki ki ki ki ki  
ki ki

k o  
ko

ko ko ko ko ko ko ko ko ko  
ko ko

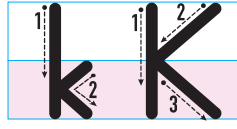

✓ Önce okuyalım, sonra yazalım.

ka → t → kat →

ke → l → kel →

ke → k → kek →

ke → t → ket →

ki → l → kil →

ki → n → kin →

ki → t → kit →

ko → l → kol →

ko → n → kon →

ko → k → kok →

ta → k → tak →

to → k → tok →

i ki iki

a → ka → aka →

ka → le → kale →

ka → no → kano →

ke → ne → kene →

ke → te → kete →

ki → lo → kilo →

ko → li → koli →

to → ka → toka →

e → tek → etek →

e → tik → etik →

i → nek → inek →

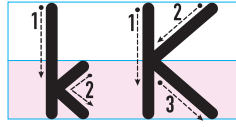

✓ Önce okuyalım, sonra yazalım.

ke kik

↓ ↓

\_\_\_\_\_

\_\_\_\_\_

ke lek

↓ ↓

\_\_\_\_\_

\_\_\_\_\_

kek lik

↓ ↓

\_\_\_\_\_

\_\_\_\_\_

tek nik

↓ ↓

\_\_\_\_\_

\_\_\_\_\_

tak lit

↓ ↓

\_\_\_\_\_

\_\_\_\_\_

tak tik

↓ ↓

\_\_\_\_\_

\_\_\_\_\_

tet kik

↓ ↓

\_\_\_\_\_

\_\_\_\_\_

kan tin

↓ ↓

\_\_\_\_\_

\_\_\_\_\_

ke nan

↓ ↓

\_\_\_\_\_

\_\_\_\_\_

et ken

↓ ↓

\_\_\_\_\_

\_\_\_\_\_

nok ta

↓ ↓

\_\_\_\_\_

\_\_\_\_\_

ka nal

↓ ↓

\_\_\_\_\_

\_\_\_\_\_

ot lak

↓ ↓

\_\_\_\_\_

\_\_\_\_\_

○ kan

↓ ↓

\_\_\_\_\_

\_\_\_\_\_

ko nak

↓ ↓

\_\_\_\_\_

\_\_\_\_\_

ki lit

↓ ↓

\_\_\_\_\_

\_\_\_\_\_

i ki li

↓ ↓ ↓

\_\_\_\_\_

le ke li

↓ ↓ ↓

\_\_\_\_\_

e lek li

↓ ↓ ↓

\_\_\_\_\_

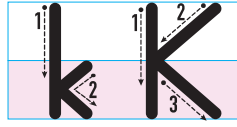

✓ Önce okuyalım, sonra yazalım.

ke kik li

↓ ↓ ↓

\_\_\_\_\_

\_\_\_\_\_

il ke li

↓ ↓ ↓

\_\_\_\_\_

\_\_\_\_\_

e lek le

↓ ↓ ↓

\_\_\_\_\_

\_\_\_\_\_

le ke le

↓ ↓ ↓

\_\_\_\_\_

\_\_\_\_\_

e ti ket

↓ ↓ ↓

\_\_\_\_\_

\_\_\_\_\_

et ki li

↓ ↓ ↓

\_\_\_\_\_

\_\_\_\_\_

ka li te

↓ ↓ ↓

\_\_\_\_\_

\_\_\_\_\_

lo kan ta

↓ ↓ ↓

\_\_\_\_\_

\_\_\_\_\_

at le tik

↓ ↓ ↓

\_\_\_\_\_

\_\_\_\_\_

ka ka o

↓ ↓ ↓

\_\_\_\_\_

\_\_\_\_\_

ko lo ni

↓ ↓ ↓

\_\_\_\_\_

\_\_\_\_\_

te ne ke

↓ ↓ ↓

\_\_\_\_\_

\_\_\_\_\_

ki lit li

↓ ↓ ↓

\_\_\_\_\_

\_\_\_\_\_

e ki li

↓ ↓ ↓

\_\_\_\_\_

\_\_\_\_\_

an ti ka

↓ ↓ ↓

\_\_\_\_\_

\_\_\_\_\_

ko a la

↓ ↓ ↓

\_\_\_\_\_

\_\_\_\_\_

ek len ti

↓ ↓ ↓

\_\_\_\_\_

\_\_\_\_\_

i let ken

↓ ↓ ↓

\_\_\_\_\_

\_\_\_\_\_



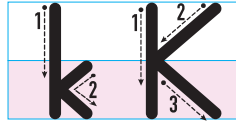

✓ Görseli verilen varlıkların isimlerini yazalım.

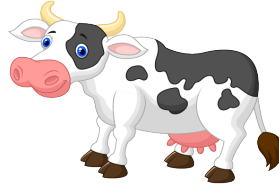
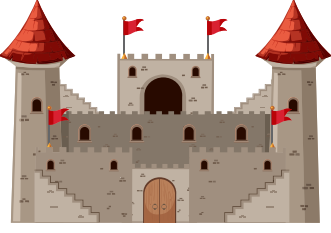

✓ Sözcükleri okuyup bulmacadan bulalım. Örnekteki gibi boyayalım.

Ö	E	E	T	E	K	N	E
E	Ö	N	A	K	İ	L	T
A	T	E	N	E	K	E	E
K	A	L	İ	T	E	K	İ
E	K	Ö	N	A	K	E	N
T	E	K	N	İ	K	K	E
K	İ	L	İ	T	L	İ	K
A	T	K	A	N	A	T	K

~~TEKNE~~

NAKİT

TENEKE

KALİTE

TEKNİK



KEK

İNEK

KONAK

KİLİTLİ

KANAT



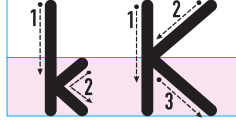

✓ Önce okuyalım, sonra yazalım.

★ Okan iki tane koli al.

Handwriting practice line with a dashed midline and a yellow shaded bottom area.

★ Anne elek ile nane ele.

Handwriting practice line with a dashed midline and a yellow shaded bottom area.

★ Tilki ile inek kol kola.

Handwriting practice line with a dashed midline and a yellow shaded bottom area.

★ Onat teneke al.

Handwriting practice line with a dashed midline and a yellow shaded bottom area.

★ Kenan on tane elek al.

Handwriting practice line with a dashed midline and a yellow shaded bottom area.

★ Anne kaliteli teneke al.

Handwriting practice line with a dashed midline and a yellow shaded bottom area.

★ Nine iki kilo kekik al.

Handwriting practice line with a dashed midline and a yellow shaded bottom area.



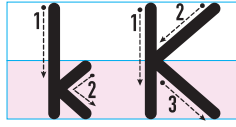

✓ Aşağıdaki cümleleri okuyup uygun görsellerle eşleştirelim.

→ Ela elekle nane ele.



→ Anne ete kekik at.

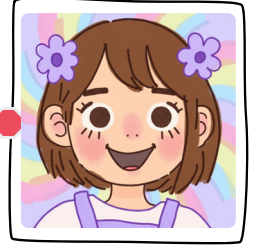

→ Kenan takla at.



→ İlke lila toka tak.

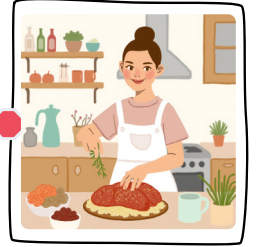

→ Nine iki kilit tak.



→ Okan lale kokla.

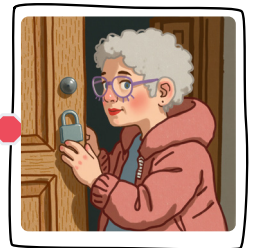

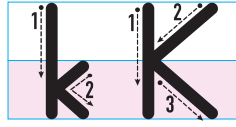

✓ Önce okuyalım, sonra yazalım.

## TOKA

İlke ile Nil el ele.  
İlke kalk toka al.  
Nil toka al, tak.  
Kaliteli toka al.  
İlke iki toka al.  
Nil'e toka al, tak.

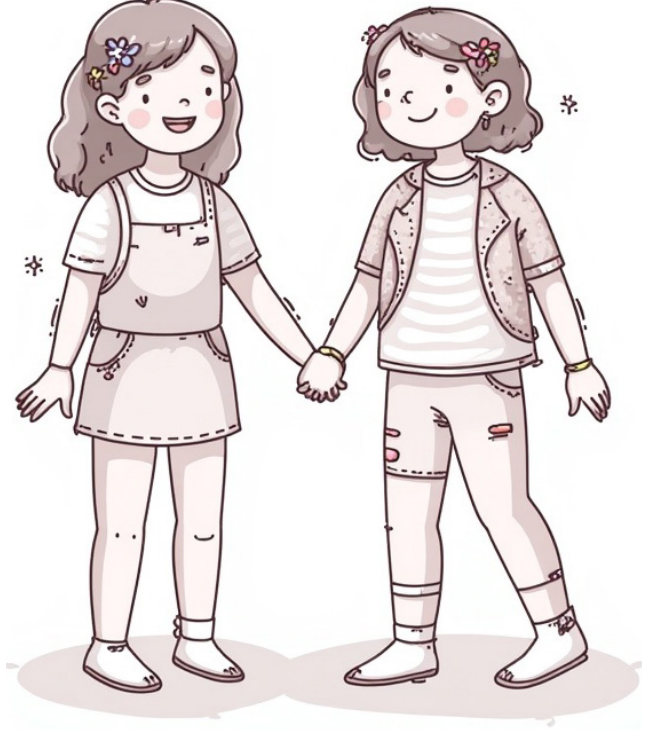

Handwriting practice line with a dashed midline and a yellow shaded bottom section.

Handwriting practice line with a dashed midline and a yellow shaded bottom section.

Handwriting practice line with a dashed midline and a yellow shaded bottom section.

Handwriting practice line with a dashed midline and a yellow shaded bottom section.

Handwriting practice line with a dashed midline and a yellow shaded bottom section.

Handwriting practice line with a dashed midline and a yellow shaded bottom section.

Handwriting practice line with a dashed midline and a yellow shaded bottom section.

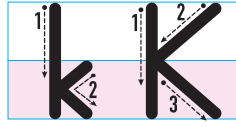

✓ Önce okuyalım, sonra yazalım.

## LOKANTA

O lokanta Ekin'in.  
Ekin kaliteli et al.  
Tekin kaliteli kek tat.  
Ekin iki kilo et al.  
Kekik al, nane al.  
Tekin iki tane kek al.



Blank writing line with a dashed midline and a yellow shaded bottom section.

Blank writing line with a dashed midline and a yellow shaded bottom section.

Blank writing line with a dashed midline and a yellow shaded bottom section.

Blank writing line with a dashed midline and a yellow shaded bottom section.

Blank writing line with a dashed midline and a yellow shaded bottom section.

Blank writing line with a dashed midline and a yellow shaded bottom section.

Blank writing line with a dashed midline and a yellow shaded bottom section.

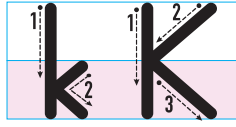

✓ Önce okuyalım, sonra yazalım.

## EKİN

Kenan ekin ekti.  
Alana ekin ekti.  
Kaliteli ekin ekti.  
Okan nane ekti.  
İlke ot ekti.  
Kenan ata ot at.



Blank writing line with a dashed midline.

Blank writing line with a dashed midline.

Blank writing line with a dashed midline.

Blank writing line with a dashed midline.

Blank writing line with a dashed midline.

Blank writing line with a dashed midline.

Blank writing line with a dashed midline.