

✓ Resimde gördüklerimizi anlatalım.

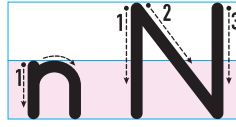

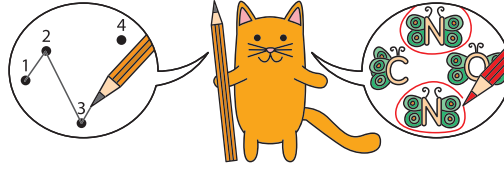

✓ 1 sayısından başlayarak sırayla rakamları birleştirelim. Oluşan görseli boyayalım. "N" harflerinin yazılı olduğu alanları örnekteki gibi yuvarlak içine alalım.





✓ Adında "n" sesi olan varlıkları boyyalım.

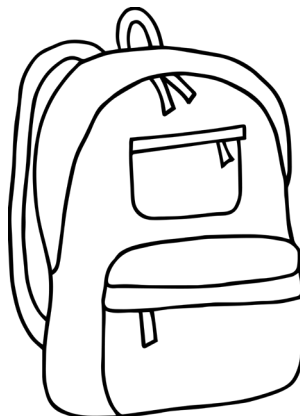
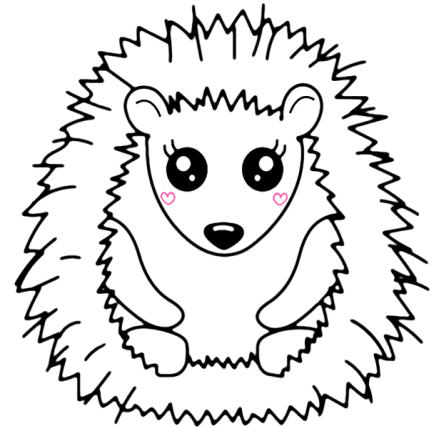
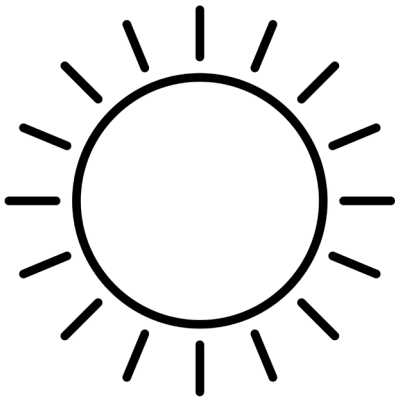
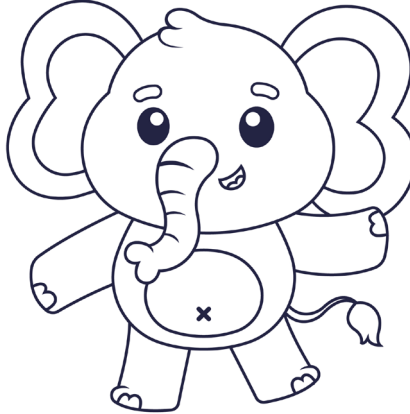
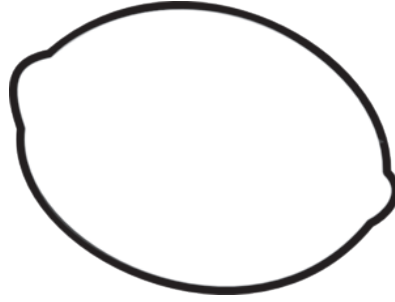
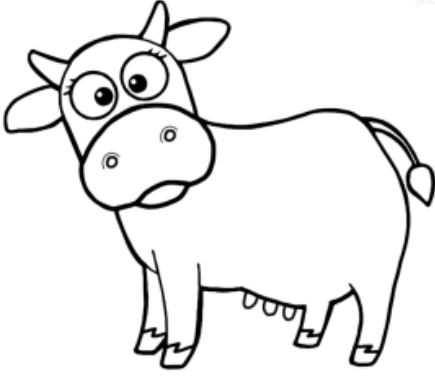

✓ Adı "n" sesi ile başlayan varlıkları işaretleyelim.

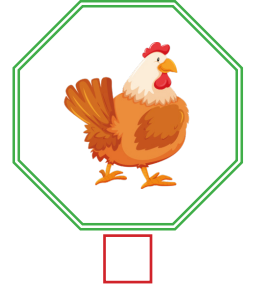
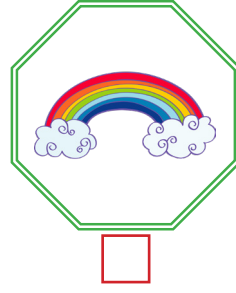
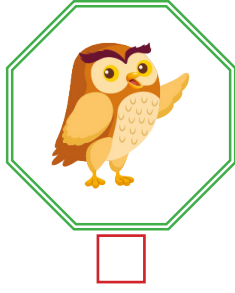
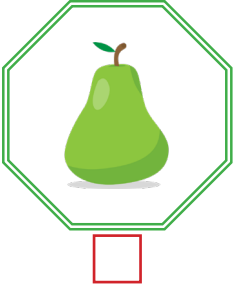
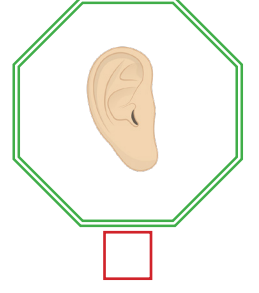
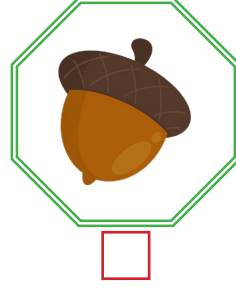
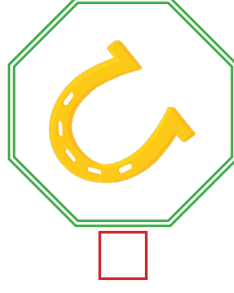
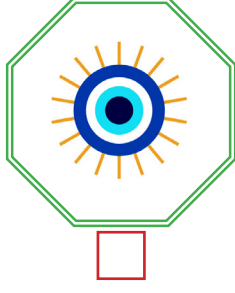
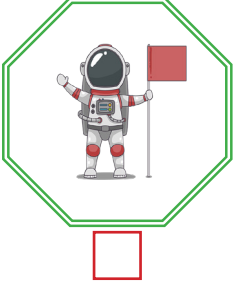

✓ Adında "n" sesi olan varlıkları işaretleyelim.

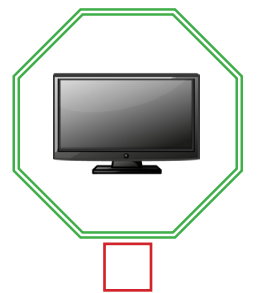
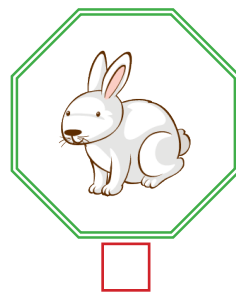
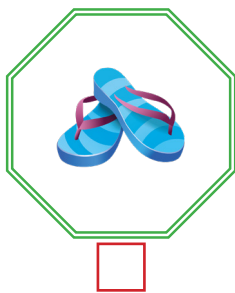
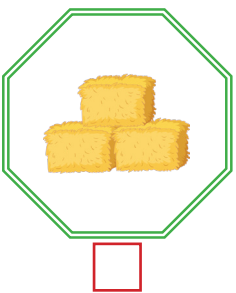
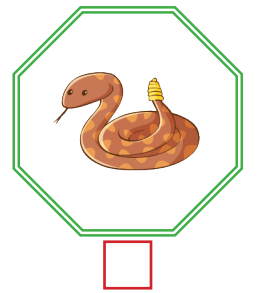
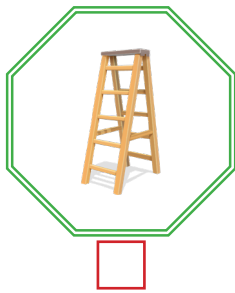
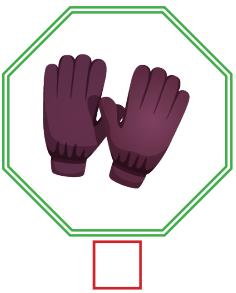
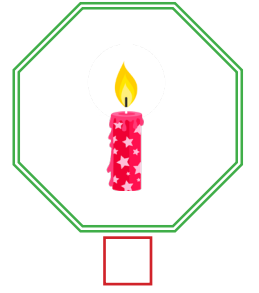
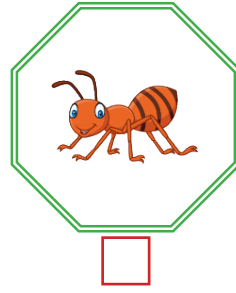
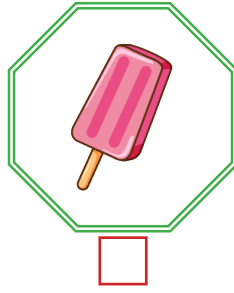
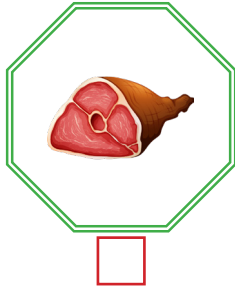

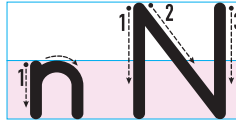

✓ Kalemleeri kullanarak 1 rakamının bulunduđu yerden başlamak şartıyla ok yönünde "n" harflerini içinden çizerek örnekteki gibi yapalım.

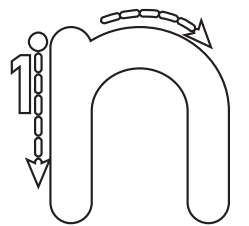
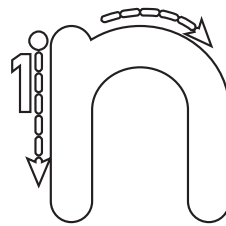
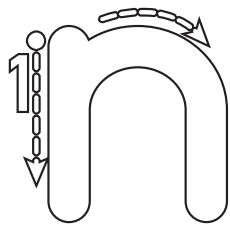
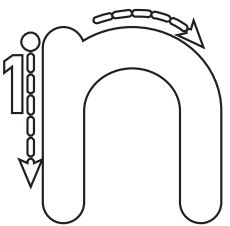
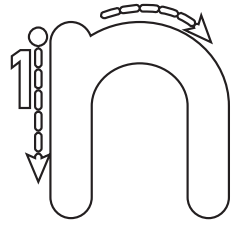
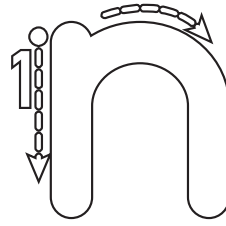
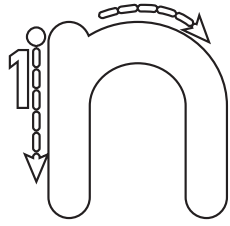
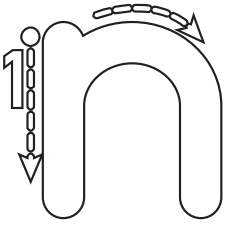
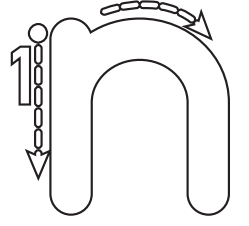
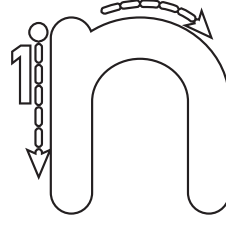
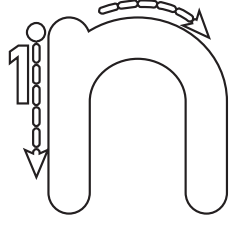
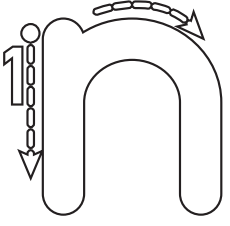
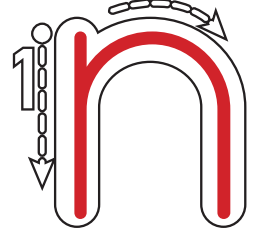
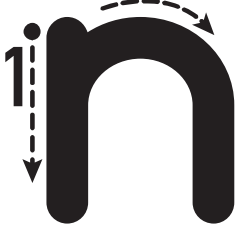

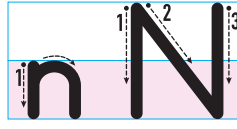

✓ "n" harflerini oyun hamuru ile yapalım.

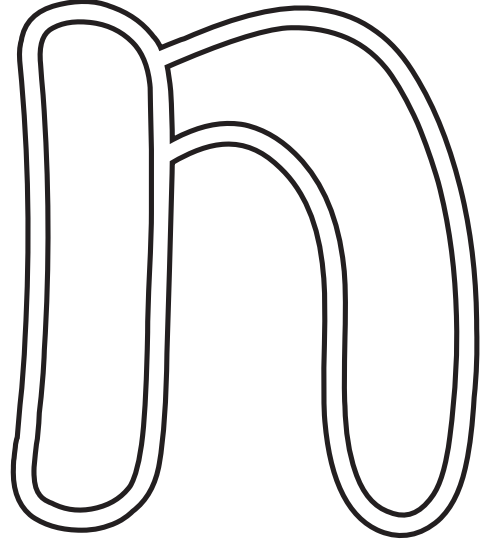
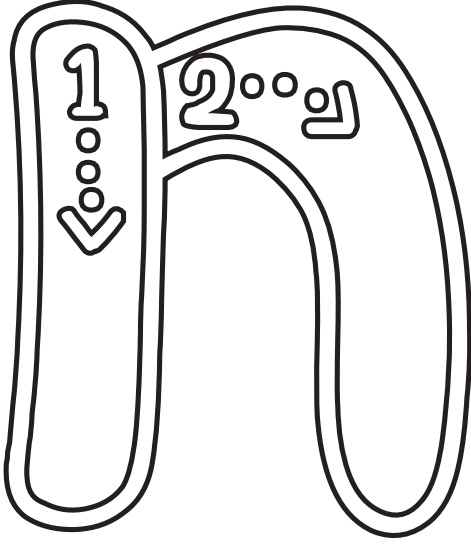

✓ adında "n" sesi olan varlıkların üzerine oyun hamurundan koyup işaretleyelim.

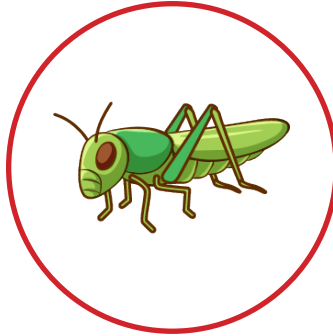
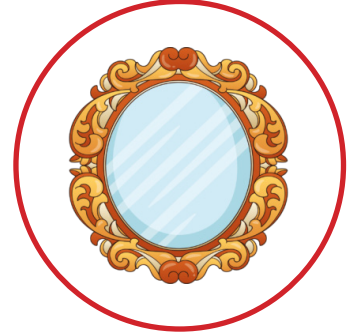



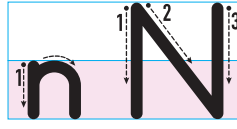

✓ "n" harfini yazalım.

n n

n n

n n

n n

n n

n n

n n

n n

n n

n n

n n

n n

n n



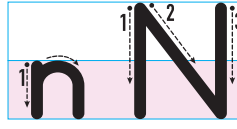

✓ Aşağıdaki satır dizgelerine “n” harfini yazalım.

n n n

n n n

n n n

n n n

n n n

n n n

n n n

n n n

n n n

n n n

n n n

n n n

n n n

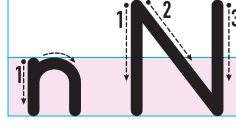

✓ Kalemleeri kullanarak 1 rakamının bulunduđu yerden başlamak şartıyla ok yönünde "N" harflerini içinden çizerek örnekteki gibi yapalım.

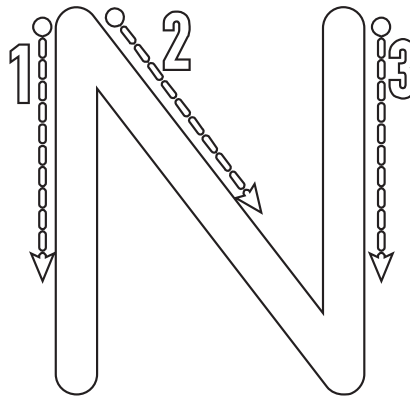
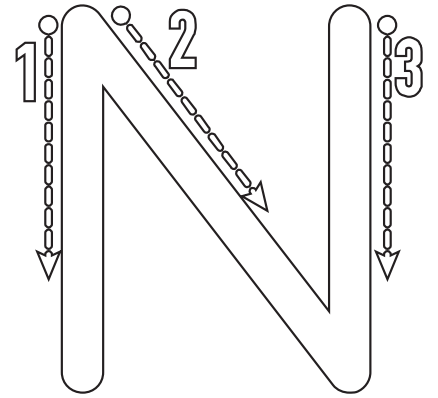
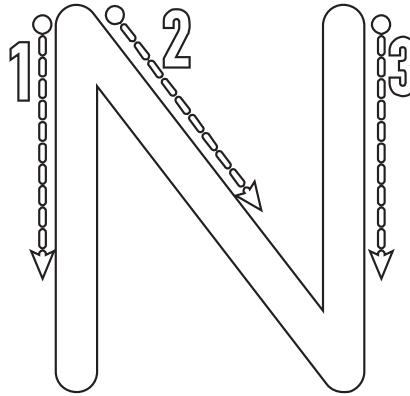
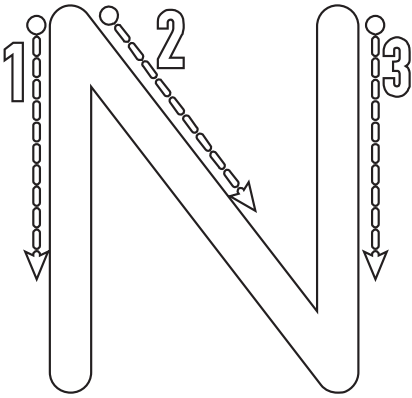
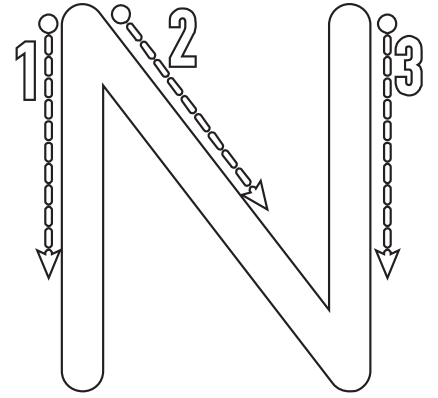
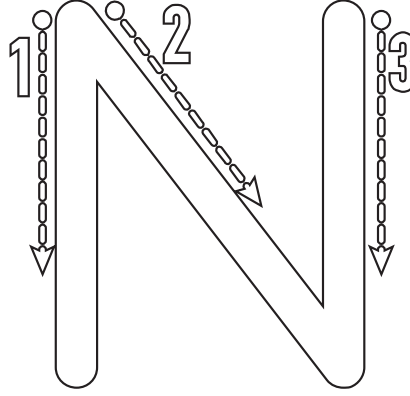
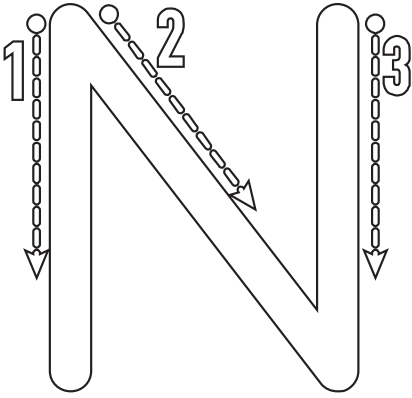
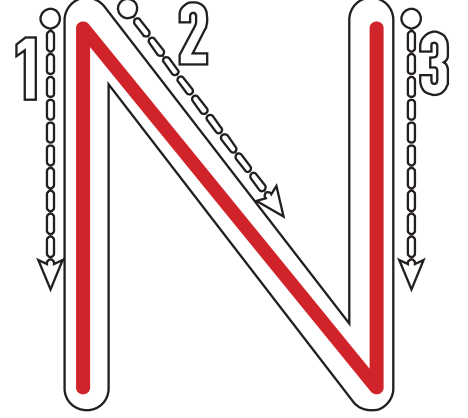
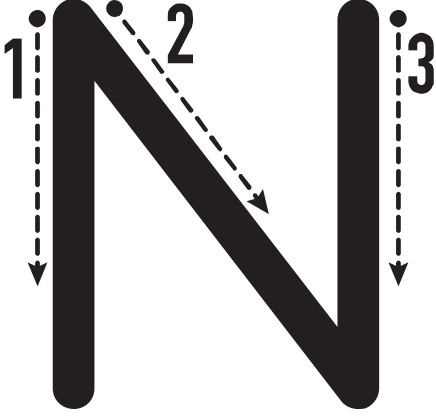

✓ "N" harflerini oyun hamuru ile yapalım.

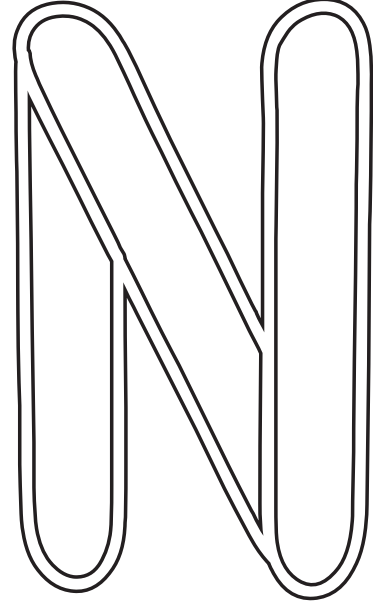
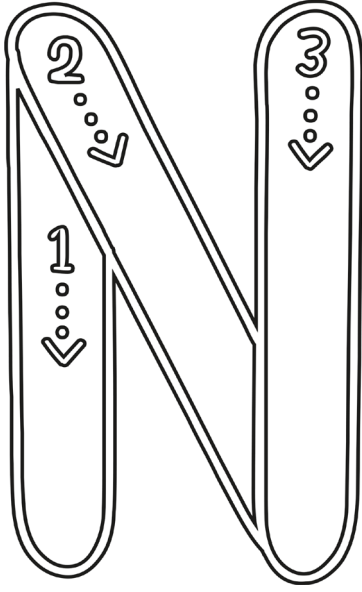

✓ adında "N" sesi olan varlıkların üzerine oyun hamurundan koyup işaretleyelim.

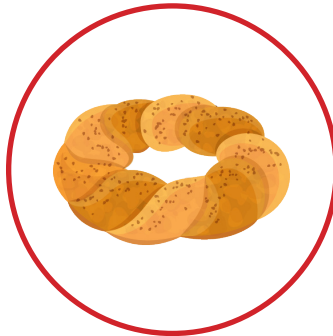

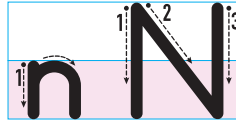

✓ "N" harfini yazalım.

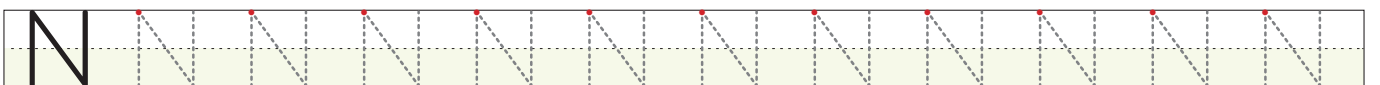
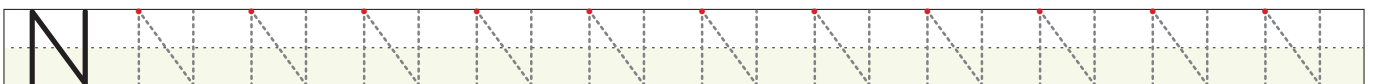
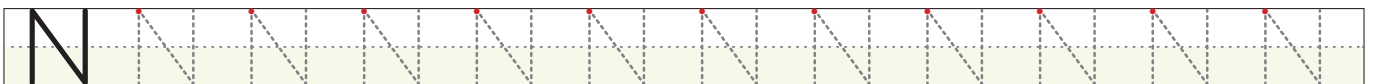
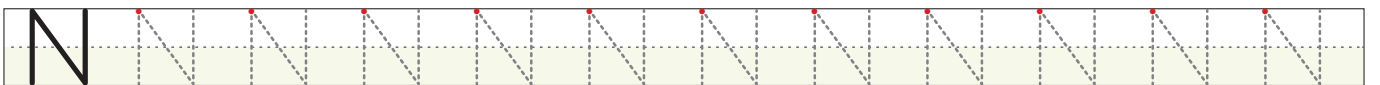
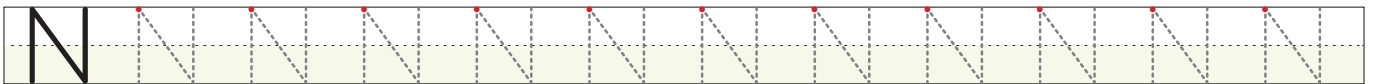
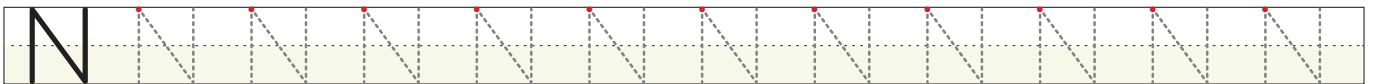
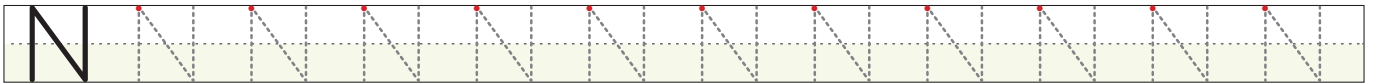
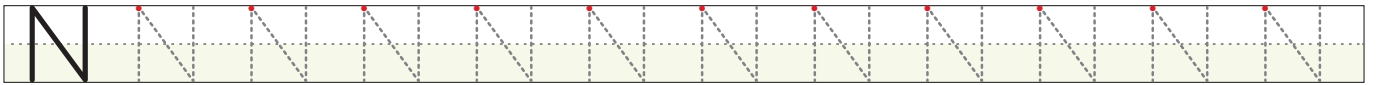
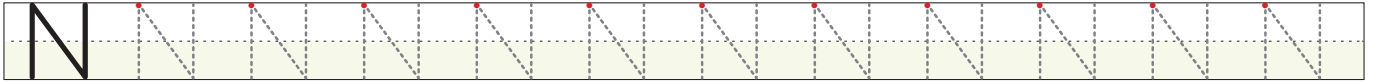
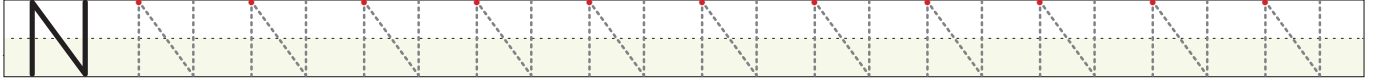

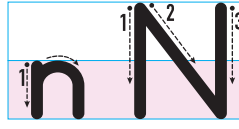

✓ "N" harfini yazalım.

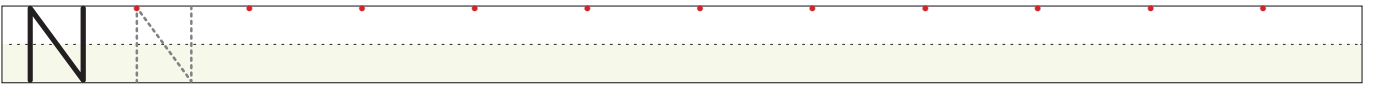
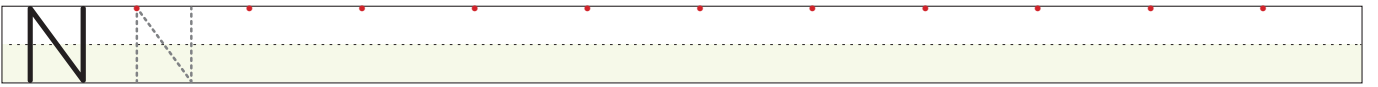
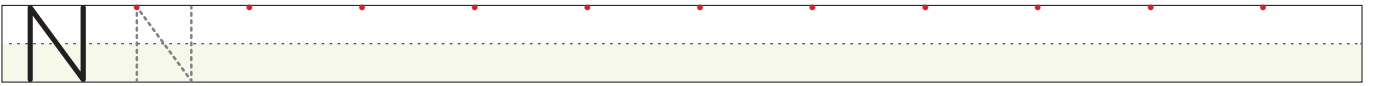
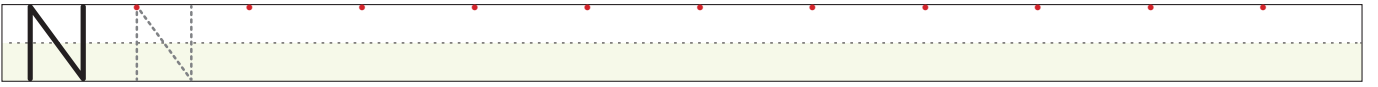
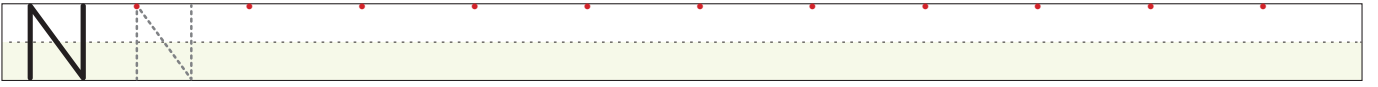
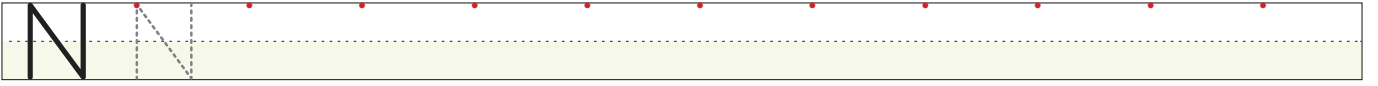
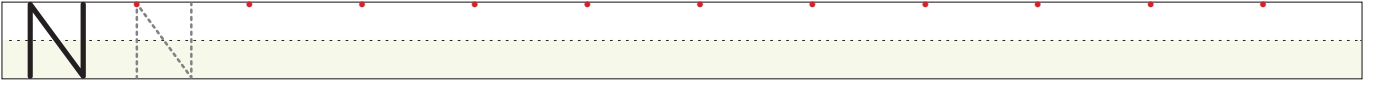
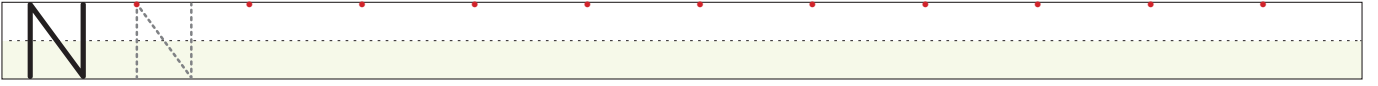
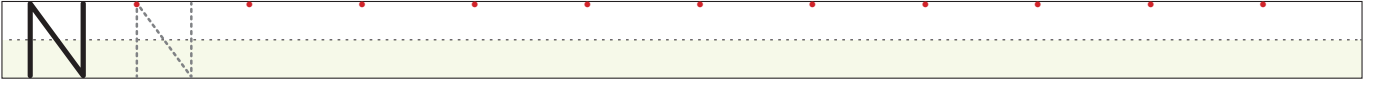
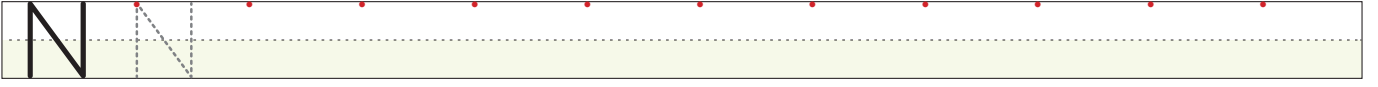
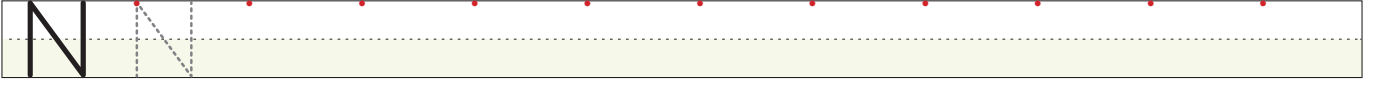



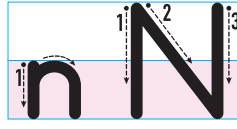

✓ Aşağıdaki satır dizgelerine "N" harfini yazalım.

N N N

N N N

N N N

N N N

N N N

N N N

N N N

N N N

N N N

N N N

N N N

N N N

N N N

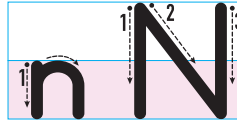

✓ Büyük ve küçük "N" harfini yazalım.

N n N n N n N n N n N n

N n N n

N n N n

N n N n

N n N n

N n N n

N n N n

N n N n

N n N n

N n N n

N n N n

N n N n

N n N n

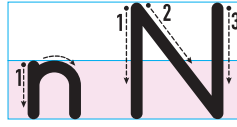

✓ Önce okuyalım, sonra yazalım.

a n an an an an an an an an  
an an an an an an an an an

an an an an an an an an an an

an an an an an an an an an an

an an an an an an an an an an

an an an an an an an an an an

an an

an an

n a na na na na na na na na  
na na na na na na na na na

na na na na na na na na na na

na na na na na na na na na na

na na na na na na na na na na

na na

na na

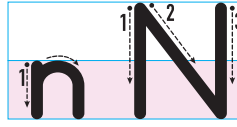

✓ Önce okuyalım, sonra yazalım.

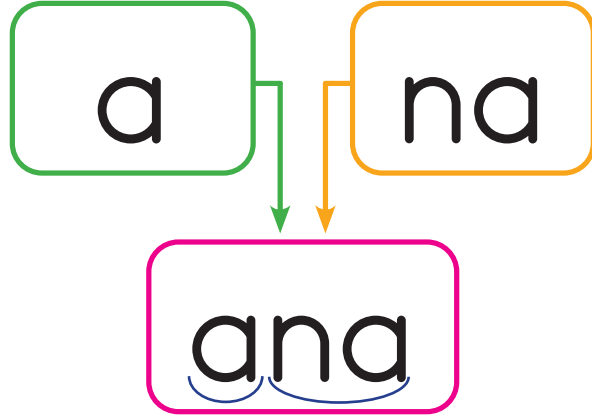

ana ana ana ana ana ana ana ana ana

ana ana ana ana ana ana ana ana ana

ana ana ana ana ana ana ana ana ana

ana ana ana ana ana ana ana ana ana

ana ana ana ana ana ana ana ana ana

ana ana ana ana ana ana ana ana ana

ana ana ana ana ana ana ana ana ana

ana ana ana ana ana ana ana ana ana

ana ana ana ana ana ana ana ana ana

ana ana ana ana ana ana ana ana ana

ana ana ana ana ana ana ana ana ana

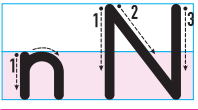

✓ Aşağıda verilen 4 görselin 3 tanesinin adı "n" harfi ile başlamaktadır. Adı "n" harfi ile başlayan görselleri boyadıktan sonra noktalı yerlerden keserek bir sonraki sayfadaki taç görselinde uygun alanlara dikkatlice yapıştıralım.

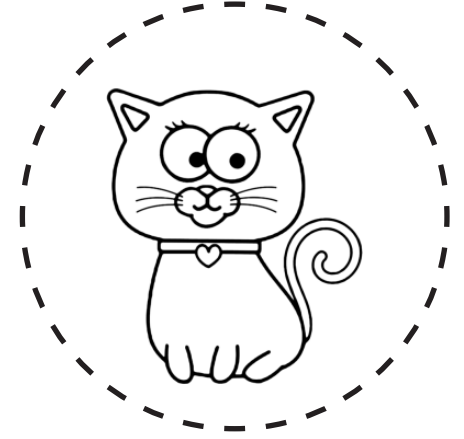

✓ Sonrasında aşağıda verilen alanlara verilen harfleri dikkatlice yazalım. Sonrasında noktalı yerlerden keserek taçın arka kısmı olacak şekilde uç uca ekleyip yapıştıralım.

