

✓ Resimde gördüklerimizi anlatalım.

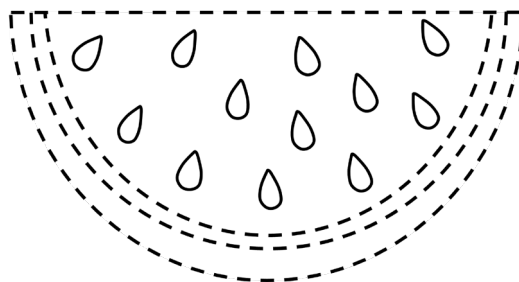

✓ Adında "u" sesi olan görsellerdeki noktaları birleştirip görseli boyayalım.

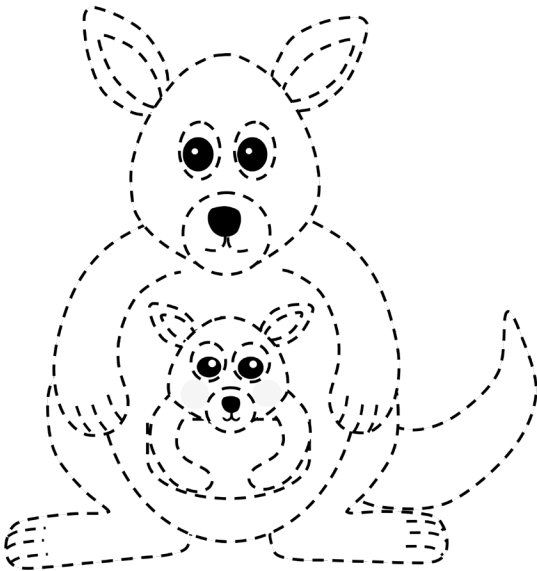
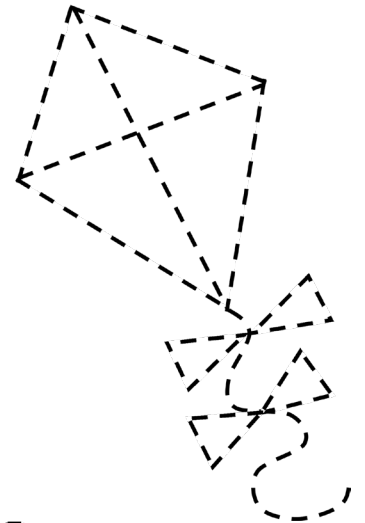
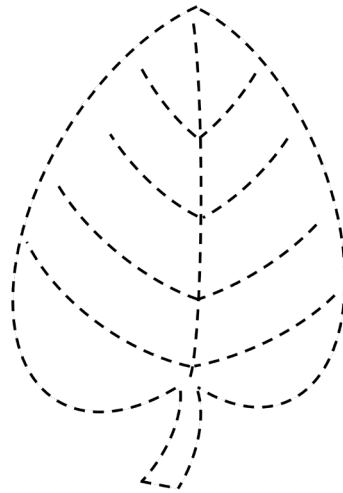
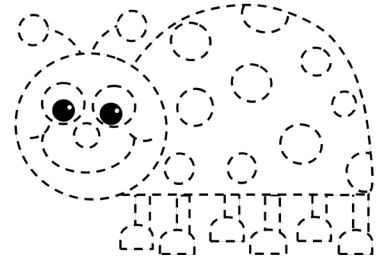
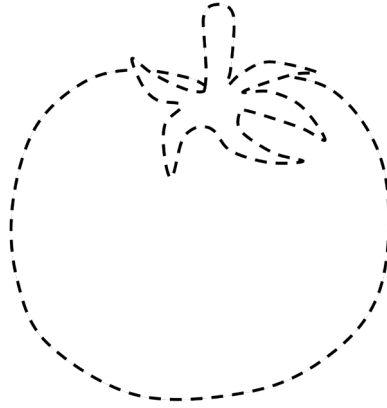
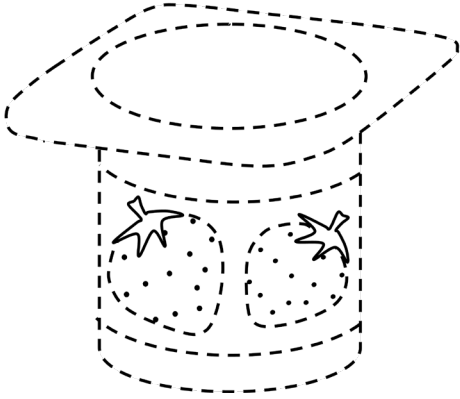
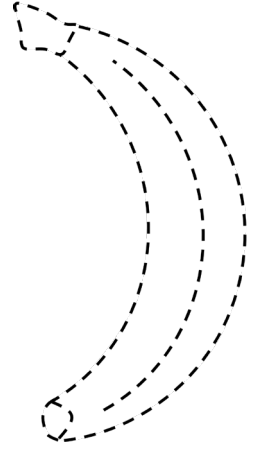
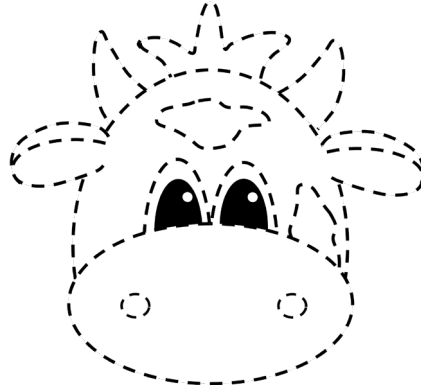
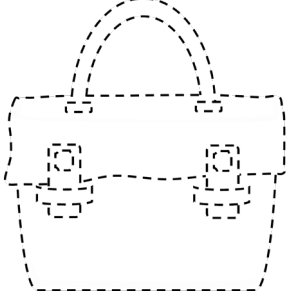

✓ Adında "u" sesi olan varlıkları işaretleyelim.

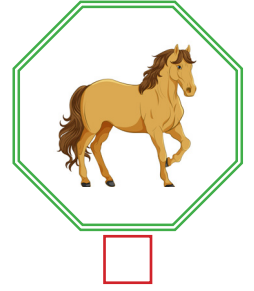
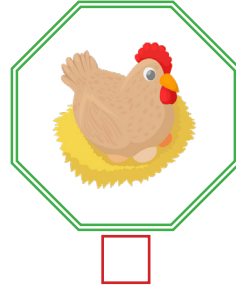
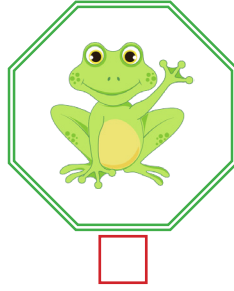
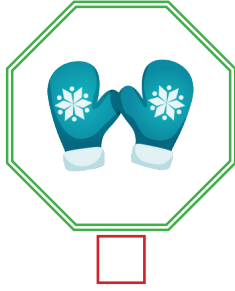
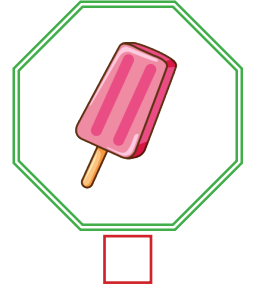
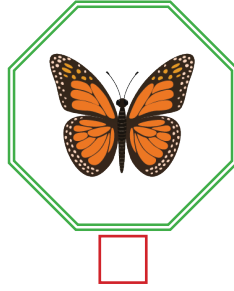
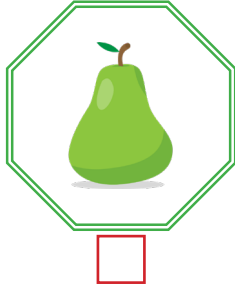
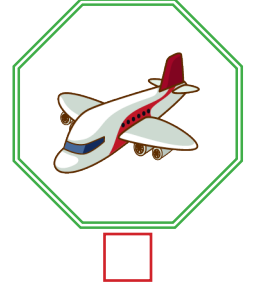
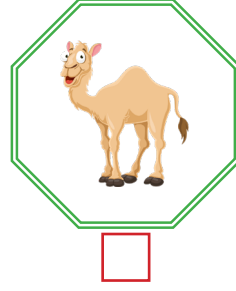
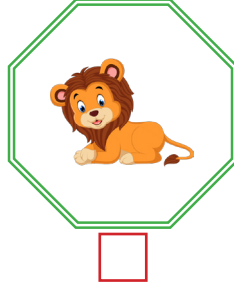
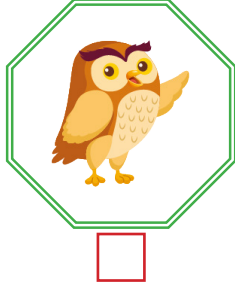
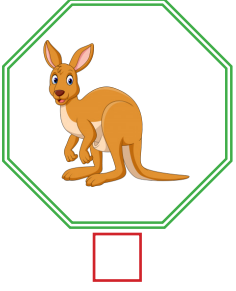

✓ Aşağıdaki görsellerin adında bulunan "u" sesi kadar kalp boyayalım.





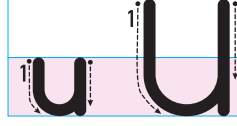

✓ Kalemleri kullanarak 1 rakamının bulunduğu yerden başlamak şartıyla ok yönünde "u" harflerini içinden çizerek örnekteki gibi yapalım.

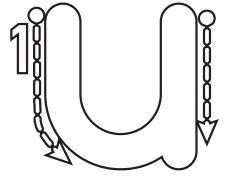
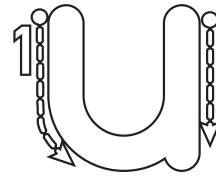
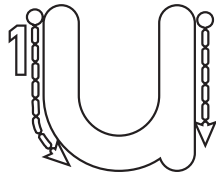
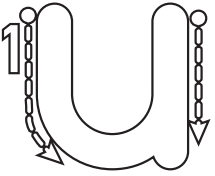
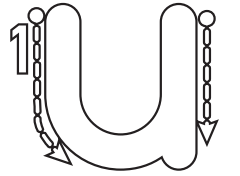
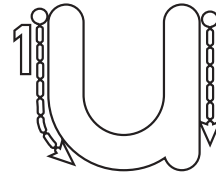
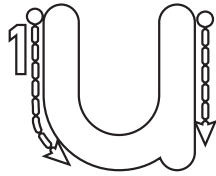
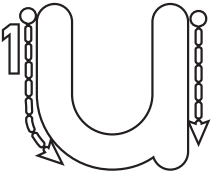
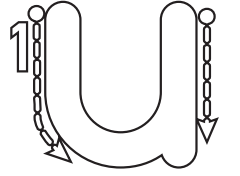
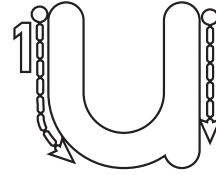
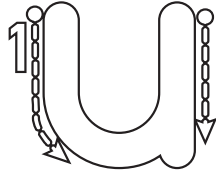
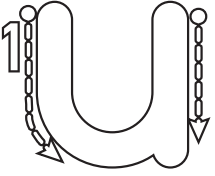
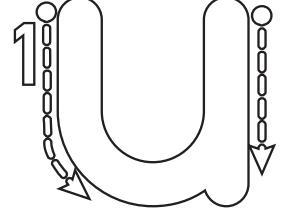
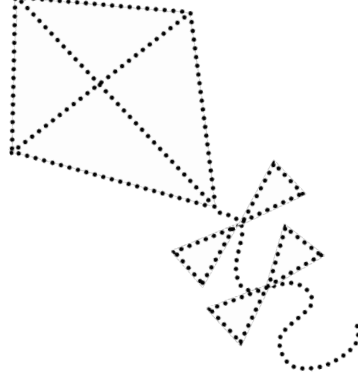
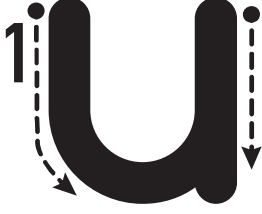

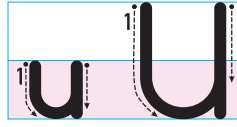

✓ "u" harfini yazalım.

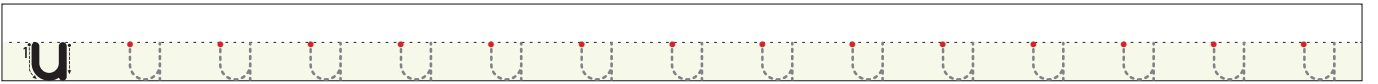
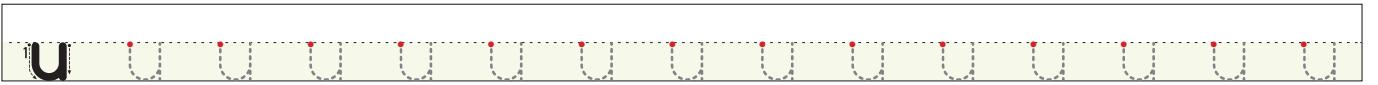
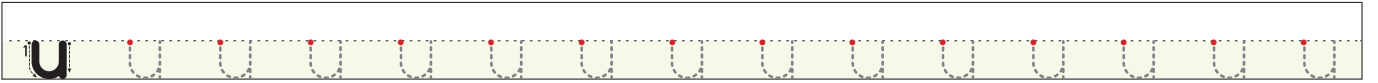
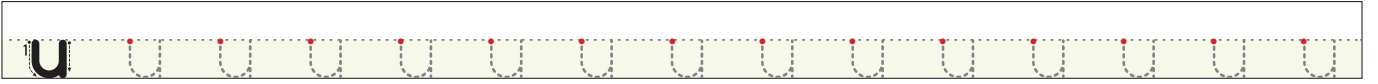
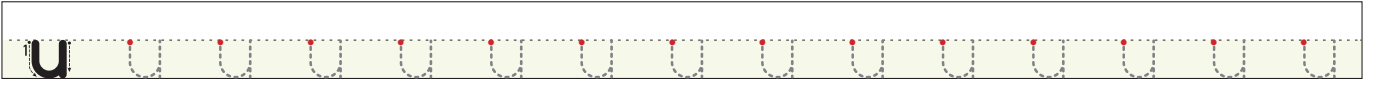
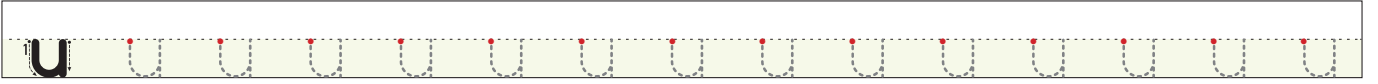
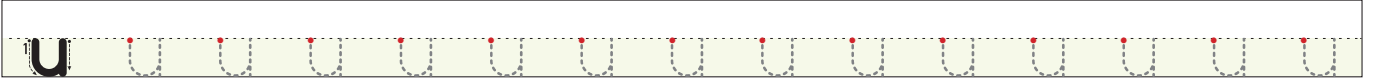
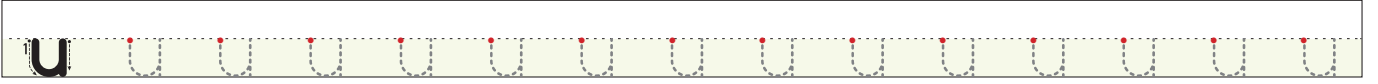
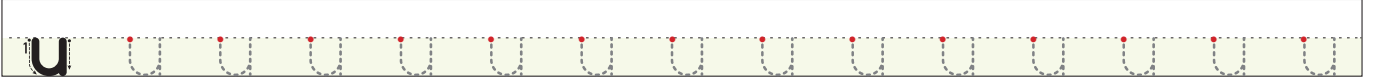
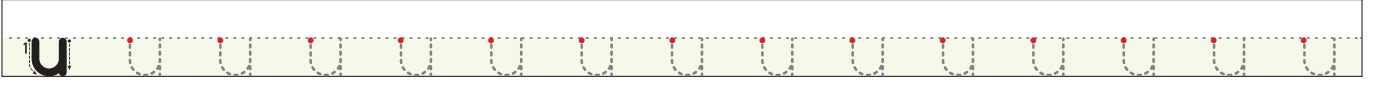
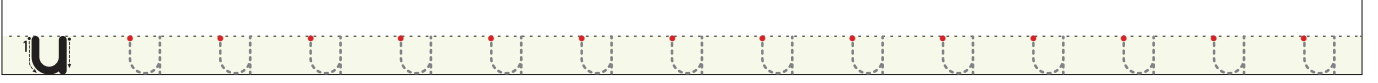
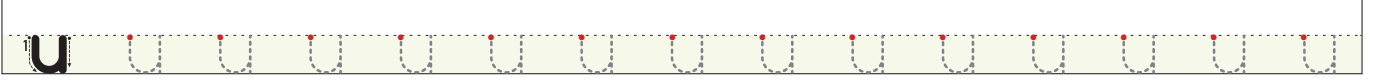
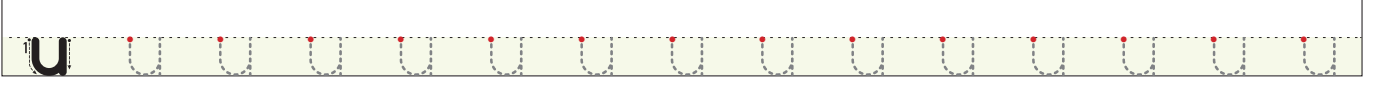

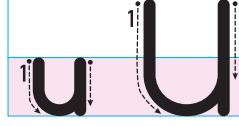

✓ "u" harfini yazalım.

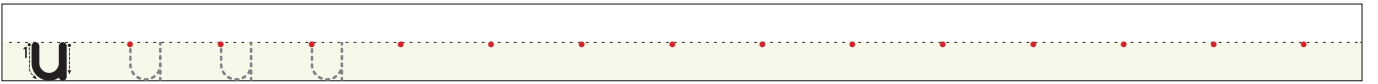
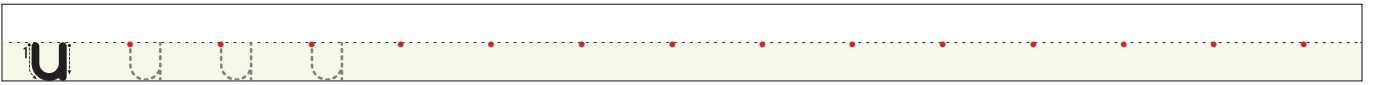
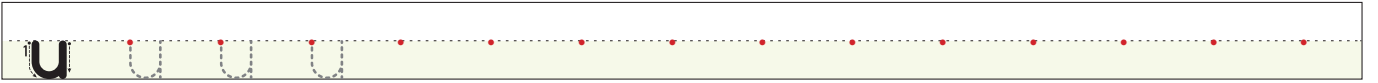
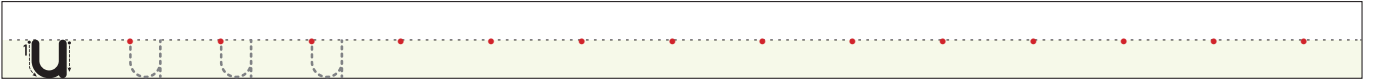
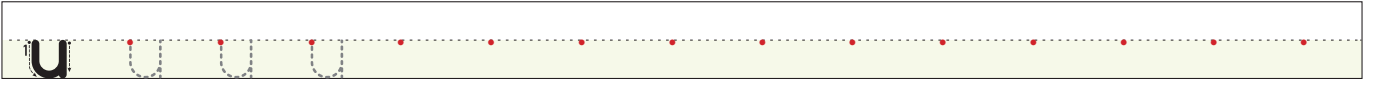
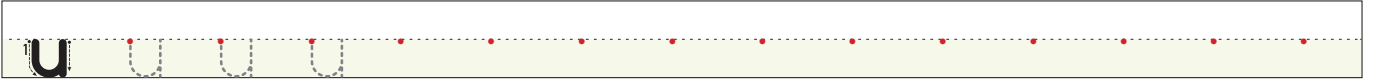
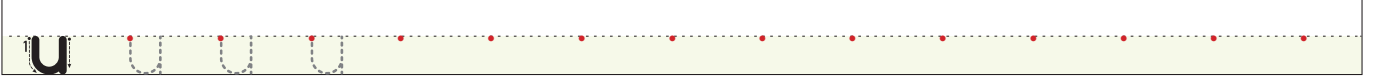

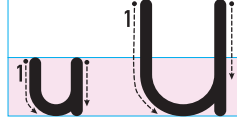

✓ Aşağıdaki satır dizgelerine “u” harfini yazalım.

u u u

u u u

u u u

u u u

u u u

u u u

u u u

u u u

u u u

u u u

u u u

u u u

u u u

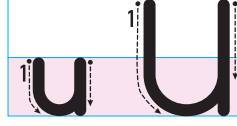

✓ Kalemli kullanarak 1 rakamının bulunduğu yerden başlamak şartıyla ok yönünde "U" harflerini içinden çizerek örnekteki gibi yapalım.

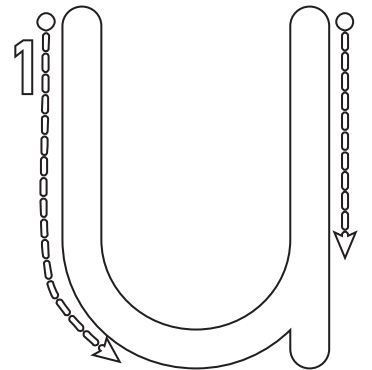
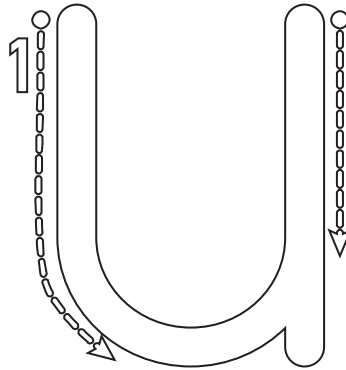
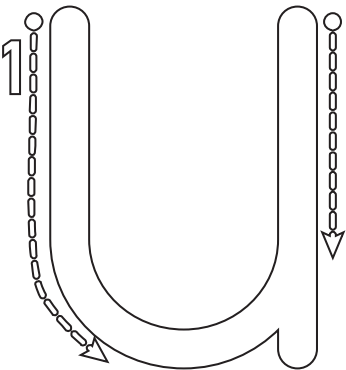
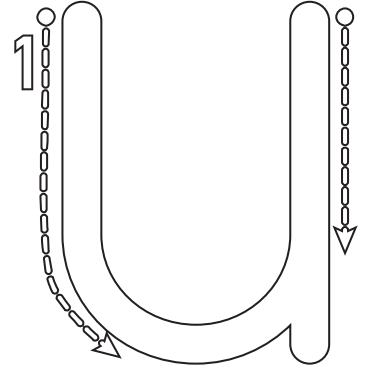
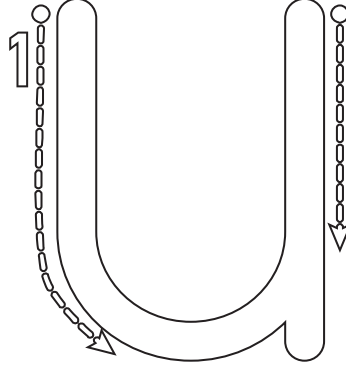
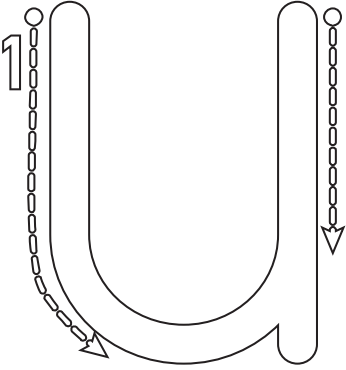
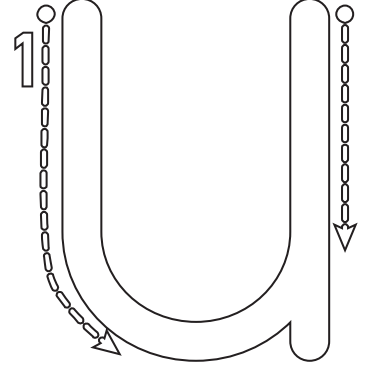
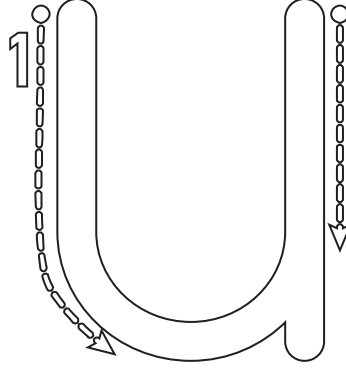
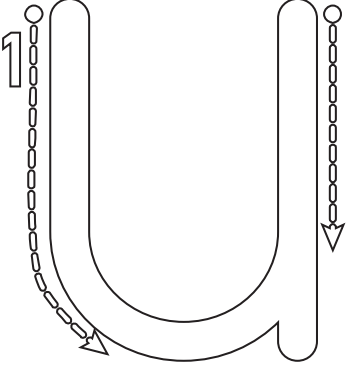
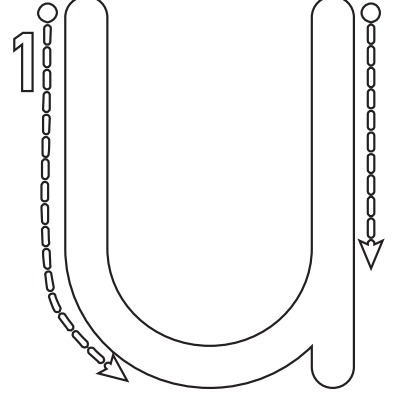
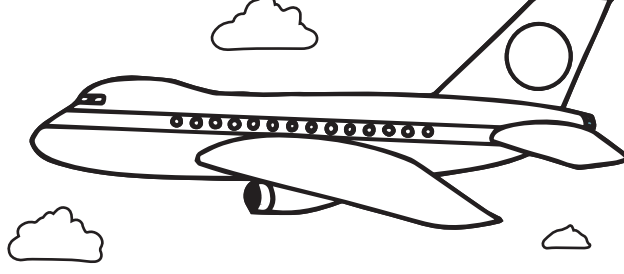
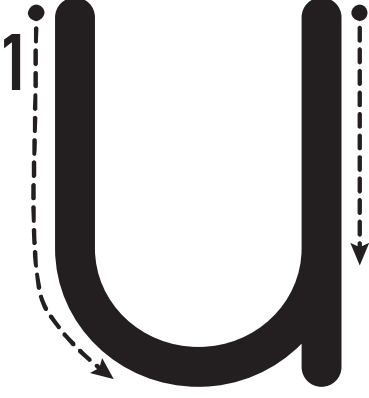

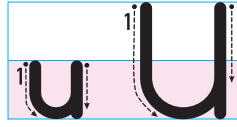

✓ "U" harfini yazalım.

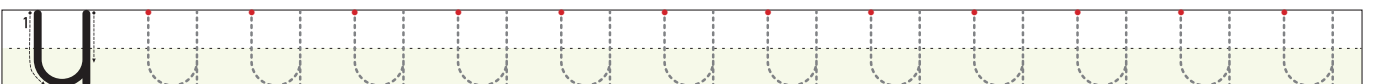
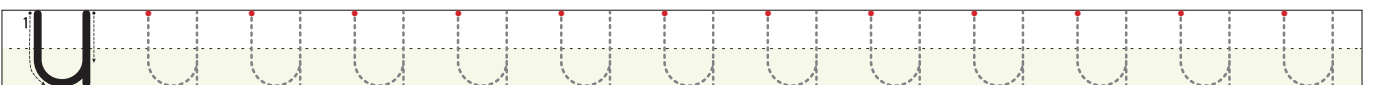
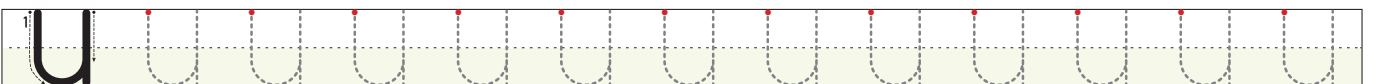
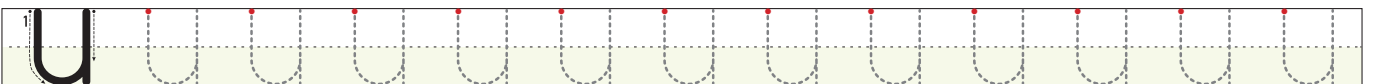
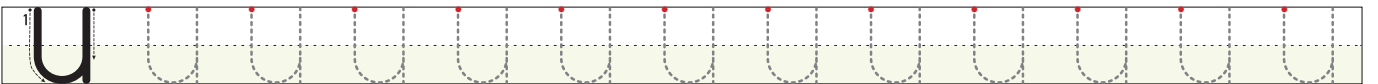
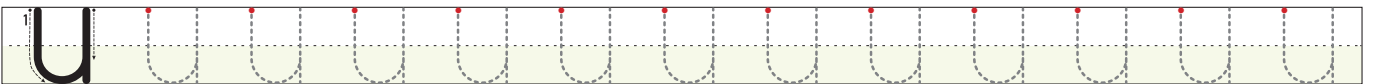
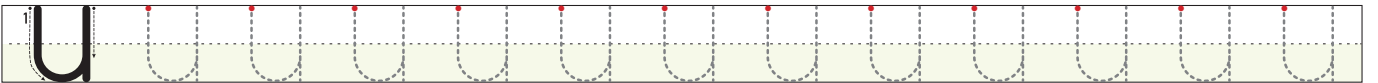
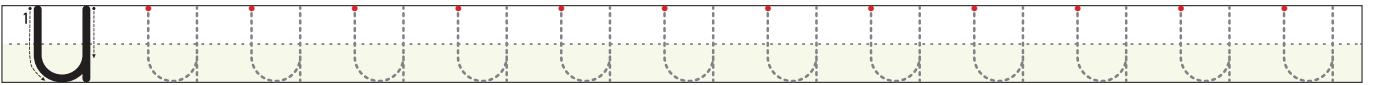
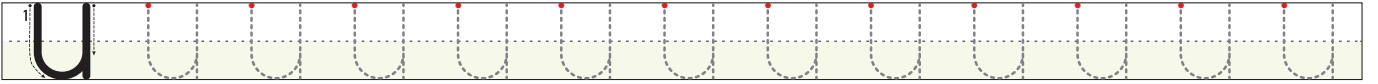
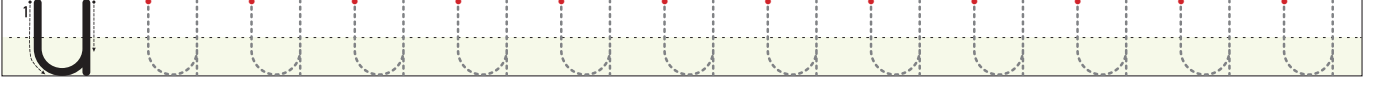

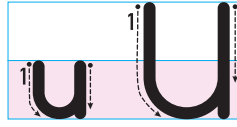

✓ "U" harfini yazalım.

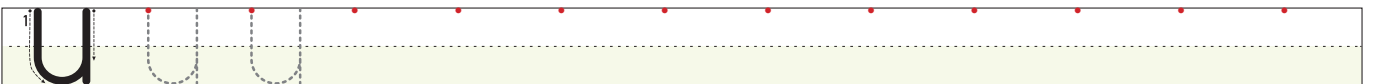
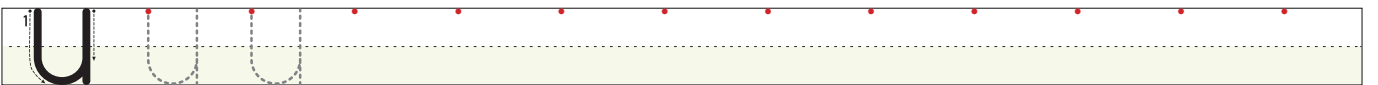
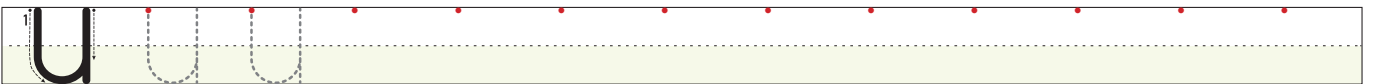
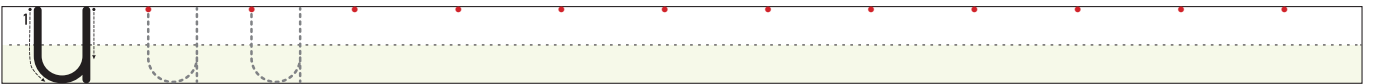
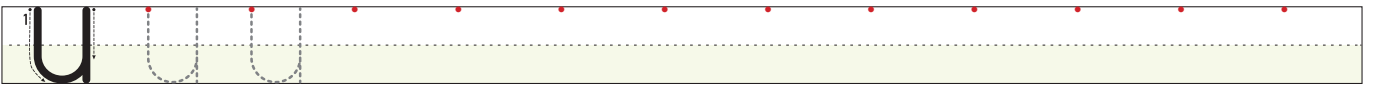
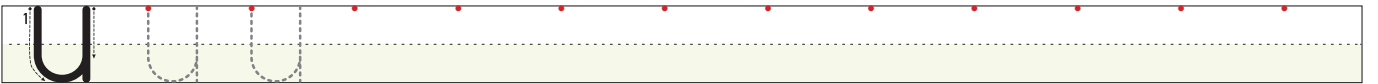
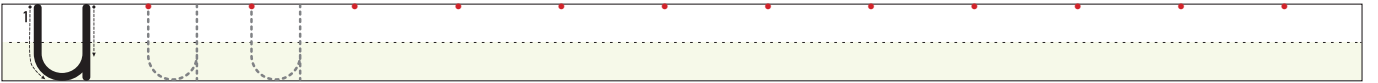
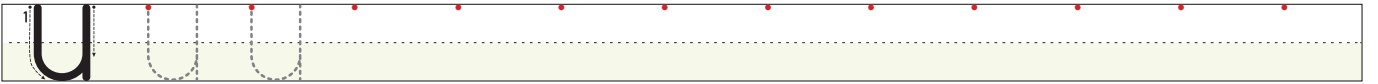
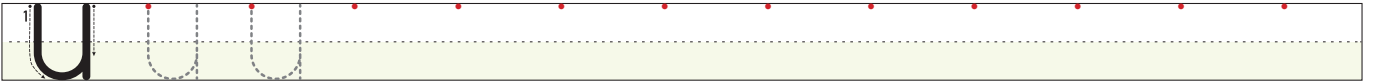
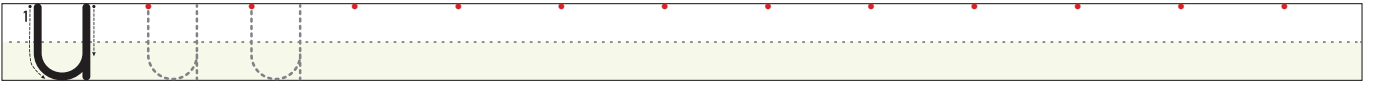
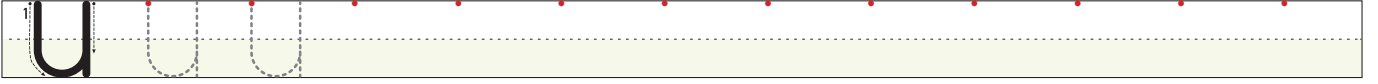
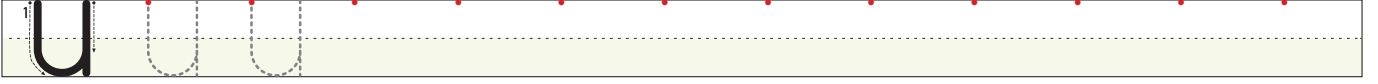

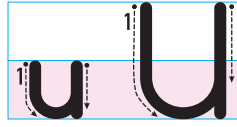

✓ Aşağıdaki satır dizgelerine "U" harfini yazalım.

u u u

u u u

u u u

u u u

u u u

u u u

u u u

u u u

u u u

u u u

u u u

u u u

u u u



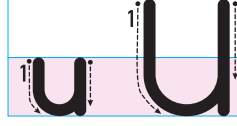

✓ Büyük ve küçük "u" harfini yazalım.

U u U u U u U u U u U u U u

U u U u

U u U u

U u U u

U u U u

U u U u

U u U u

U u U u

U u U u

U u U u

U u U u

U u U u

U u U u

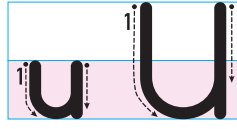

✓ Önce okuyalım, sonra yazalım.

u n  
un

un un un un un un un un  
un un

u t  
ut

ut ut ut ut ut ut ut ut ut  
ut ut

u l  
ul

ul ul ul ul ul ul ul ul ul ul  
ul ul

u k  
uk

uk uk uk uk uk uk uk uk uk  
uk uk



n u  
nu

nu nu nu nu nu nu nu nu  
nu nu

t u  
tu

tu tu tu tu tu tu tu tu tu  
tu tu

l u  
lu

lu lu lu lu lu lu lu lu lu  
lu lu

k u  
ku

ku ku ku ku ku ku ku ku ku  
ku ku

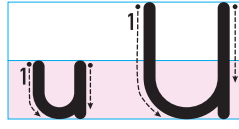

✓ Önce okuyalım, sonra yazalım.

ku → l → kul → kat

ot → lu → otlu →

ku → t → kut →

ku → le → kule →

tu → t → tut →

kut → lu → kutlu →

u → lu → ulu →

kuk → la → kukla →

o → tu → otu →

ku → lak → kulak →

u → nu → unu →

tut → ku → tutku →

o → ku → oku →

ko → nuk → konuk →

ku → tu → kutu →

un → luk → unluk →

ko → nu → konu →

tut → kal → tutkal →

on → lu → onlu →

tu → na → Tuna →

o → kul → okul →

kut → la → kutla →

un → lu → unlu →

kol → luk → kolluk →

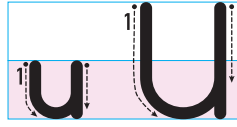

✓ Önce okuyalım, sonra yazalım.

ki lo lu

Blank writing line with a yellow highlight at the bottom.

ko ku lu

Blank writing line with a yellow highlight at the bottom.

ku tu lu

Blank writing line with a yellow highlight at the bottom.

u nut kan

Blank writing line with a yellow highlight at the bottom.

o kul lu

Blank writing line with a yellow highlight at the bottom.

tu tuk lu

Blank writing line with a yellow highlight at the bottom.

tut ku lu

Blank writing line with a yellow highlight at the bottom.

kol tuk lu

Blank writing line with a yellow highlight at the bottom.

il ko kul

Blank writing line with a yellow highlight at the bottom.

u lu luk

Blank writing line with a yellow highlight at the bottom.

tan tu ni

Blank writing line with a yellow highlight at the bottom.

ko nu lu

Blank writing line with a yellow highlight at the bottom.

ku le li

Blank writing line with a yellow highlight at the bottom.

o nun ki

Blank writing line with a yellow highlight at the bottom.

o luk lu

Blank writing line with a yellow highlight at the bottom.

ku lak lı

Blank writing line with a yellow highlight at the bottom.

a na o ku lu

Blank writing line with a yellow highlight at the bottom.

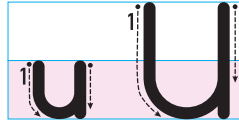

✓ Okuduğunuz sözcüklerin renklerine uygun olarak resmi boyayalım. Boş kalan alanlara boyama yapmayalım.

kutu

okul

konuk

kukla

kul

konu

kulak

kule

tutku

kutlu

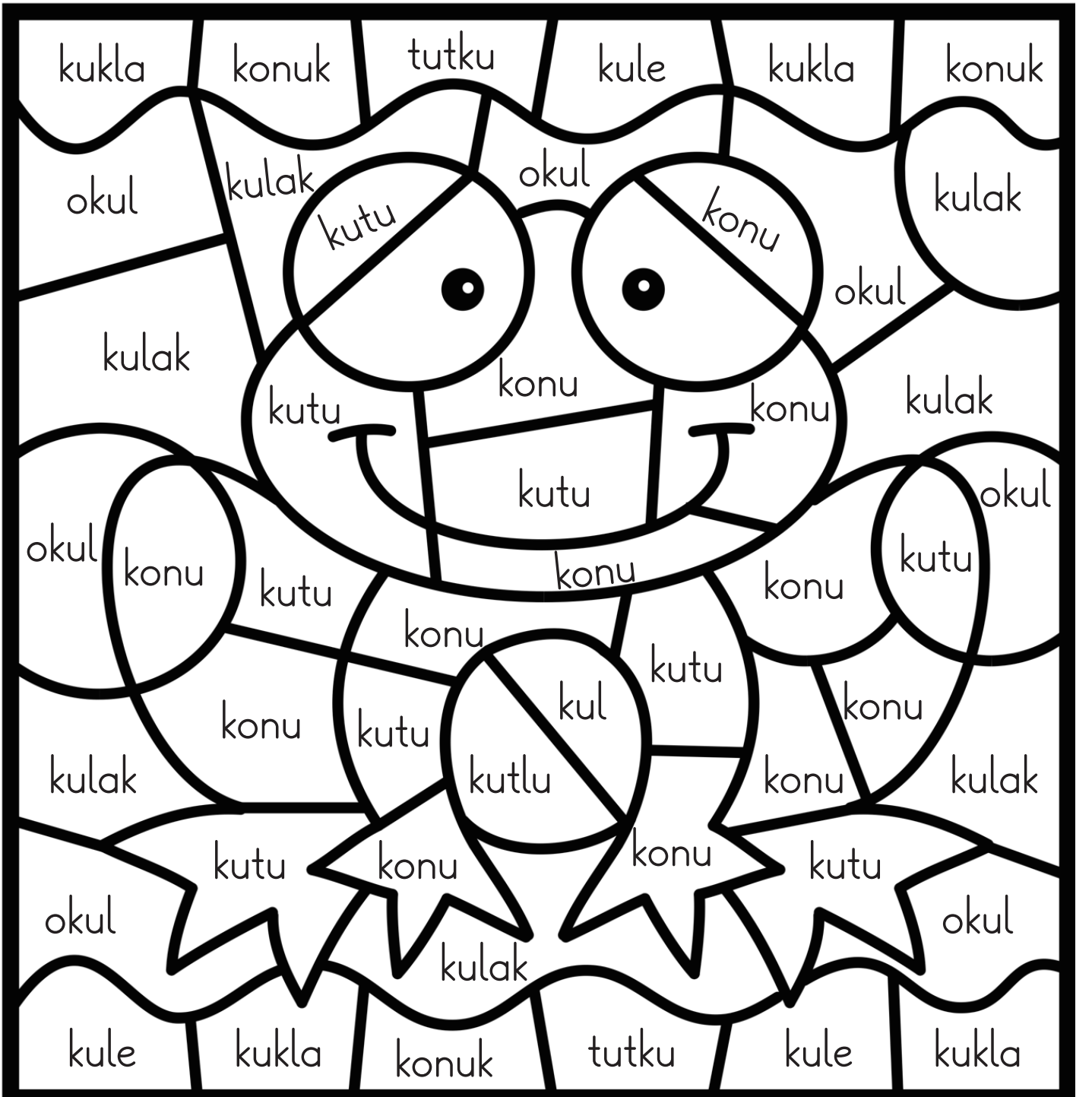

✓ Görseli verilen varlıkların isimlerini yazalım.

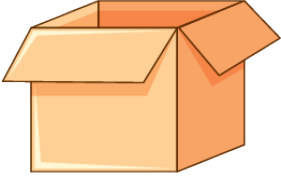

\_\_\_\_\_

\_\_\_\_\_

\_\_\_\_\_

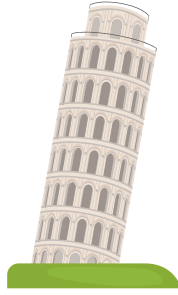
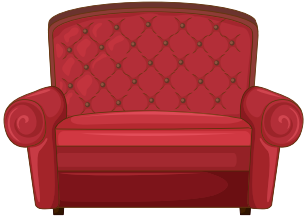

\_\_\_\_\_

\_\_\_\_\_

\_\_\_\_\_

✓ Sözcükleri okuyup bulmacadan bulalım. Örnekteki gibi boyayalım.

A	K	O	K	U	K	E	U
K	A	T	U	T	K	A	L
O	K	E	K	U	T	L	U
L	U	E	K	U	K	L	A
T	L	E	K	U	L	A	K
U	E	K	O	N	U	K	İ
K	N	L	İ	K	U	T	U
E	T	İ	T	U	T	K	U

~~KOKU~~

TUTKU

KOLTUK

TUTKAL

KULE



KUTLU

KUTU

KONUK

KULAK

KUKLA



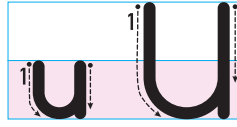

✓ Önce okuyalım, sonra yazalım.

★ Ela iki tane kukla al.

Handwriting practice line for the sentence "Ela iki tane kukla al." consisting of a solid top line, a dashed middle line, and a solid bottom line.

★ Tuna kokulu kek al.

Handwriting practice line for the sentence "Tuna kokulu kek al." consisting of a solid top line, a dashed middle line, and a solid bottom line.

★ Kutlu koluna kolluk tak.

Handwriting practice line for the sentence "Kutlu koluna kolluk tak." consisting of a solid top line, a dashed middle line, and a solid bottom line.

★ Nalan, kotunu katla.

Handwriting practice line for the sentence "Nalan, kotunu katla." consisting of a solid top line, a dashed middle line, and a solid bottom line.

★ Anne kokulu nane al.

Handwriting practice line for the sentence "Anne kokulu nane al." consisting of a solid top line, a dashed middle line, and a solid bottom line.

★ Ali okullu ol, oku.

Handwriting practice line for the sentence "Ali okullu ol, oku." consisting of a solid top line, a dashed middle line, and a solid bottom line.

★ Tekin ninene notunu oku.

Handwriting practice line for the sentence "Tekin ninene notunu oku." consisting of a solid top line, a dashed middle line, and a solid bottom line.

✓ Aşağıdaki cümleleri okuyup uygun görsellerle eşleştirelim.

→ Anne elekle un ele.



→ Utku keki kokla.

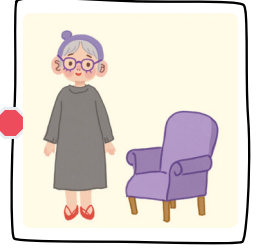

→ Ali kolluk kullan.

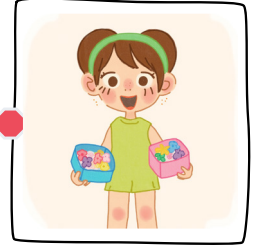

→ Nine lila koltuk al.



→ Tuna otu ata at.



→ Nil iki kutu toka al.





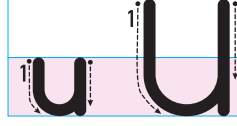

✓ Önce okuyalım, sonra yazalım.

## UN ELE

Nil iki kilo un al.

Un ile elek al.

Nil unu ele.

Elekle un ele.

Kutu kutu un ele.

Nil'in eli unlu.



Handwriting practice line with a dashed midline and a yellow shaded bottom section.

Handwriting practice line with a dashed midline and a yellow shaded bottom section.

Handwriting practice line with a dashed midline and a yellow shaded bottom section.

Handwriting practice line with a dashed midline and a yellow shaded bottom section.

Handwriting practice line with a dashed midline and a yellow shaded bottom section.

Handwriting practice line with a dashed midline and a yellow shaded bottom section.

Handwriting practice line with a dashed midline and a yellow shaded bottom section.

✓ Önce okuyalım, sonra yazalım.

## TOKA

Tutku kalk toka al.

İki kutu toka al.

1 kutu annene al.

1 kutu ninene al.

Kutu kutu al.

Tane tane al.



Handwriting practice line with a dashed midline and a yellow shaded bottom section.

Handwriting practice line with a dashed midline and a yellow shaded bottom section.

Handwriting practice line with a dashed midline and a yellow shaded bottom section.

Handwriting practice line with a dashed midline and a yellow shaded bottom section.

Handwriting practice line with a dashed midline and a yellow shaded bottom section.

Handwriting practice line with a dashed midline and a yellow shaded bottom section.

Handwriting practice line with a dashed midline and a yellow shaded bottom section.

✓ Önce okuyalım, sonra yazalım.

## KEK

Anne kakao al.

Kakao ile un al.

Anne unu ele.

Una kakao ekle.

Utku kek al.

Utku kokulu kek al.



Blank writing line with a dashed midline.

Blank writing line with a dashed midline.

Blank writing line with a dashed midline.

Blank writing line with a dashed midline.

Blank writing line with a dashed midline.

Blank writing line with a dashed midline.

Blank writing line with a dashed midline.