

1. Aşağıdaki görseller, yanlarında verilen hangi geometrik cisme benziyor? İşaretleyelim.

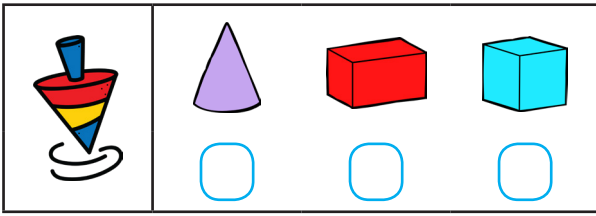

2. Aşağıdaki geometrik cisimleri yüzleriyle ve yüzün ismiyle örnekteki gibi aynı renge boyayarak eşleştirelim.

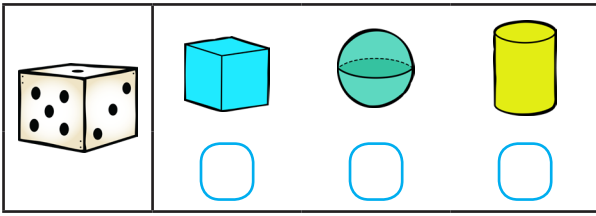
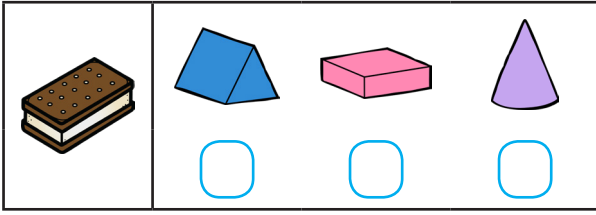
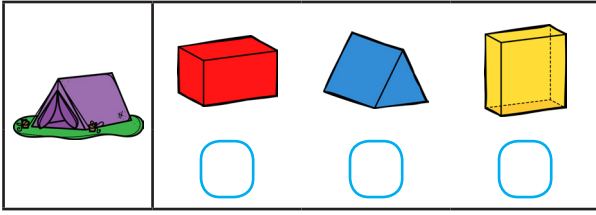
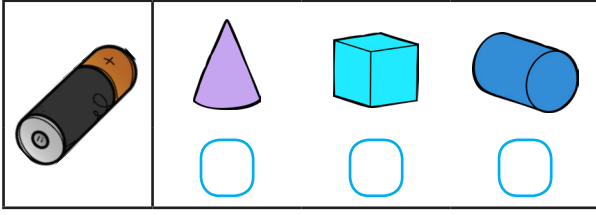
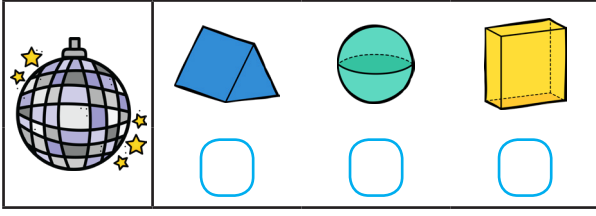
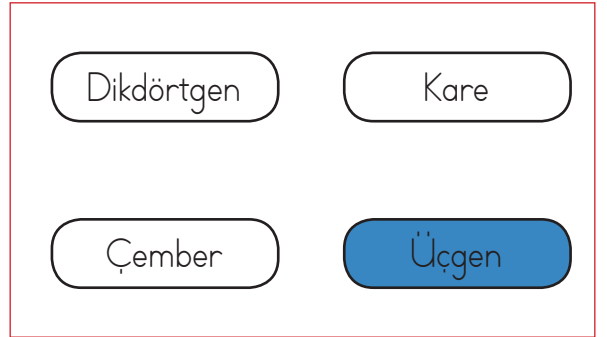
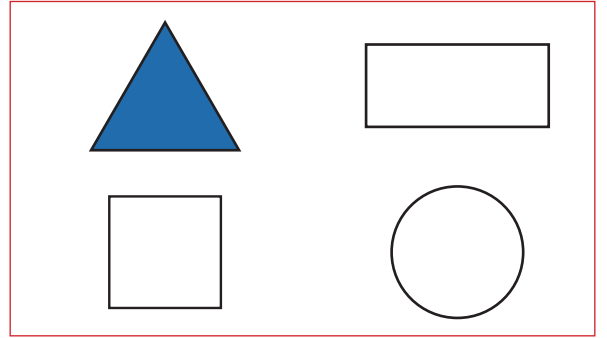
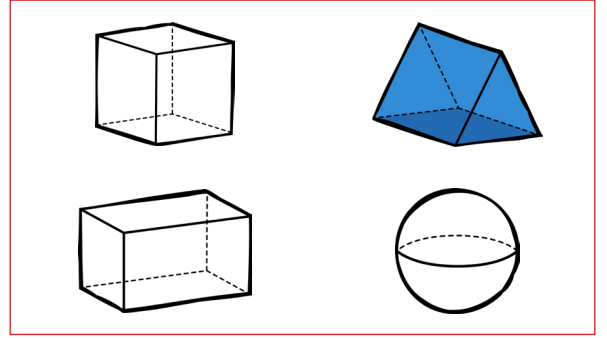

4. Aşağıdaki görsellerden özellikleri diğerlerinden farklı olanı boyayalım.

